



TIMBER NOTICE OF SALE

SALE NAME: GHOST TOWN SORTS

AGREEMENT NO: 30-106329 - 30-106335

AUCTION: June 13, 2024 starting at 10:00 a.m.
Pacific Cascade Region Office, Castle Rock, WA

COUNTY: Cowlitz

SALE LOCATION: Sale located approximately 10 miles east of Toutle, WA

**PRODUCTS SOLD
AND SALE AREA:**

All delivered logs, except leave trees marked with blue paint, trees bound with yellow "Leave Tree Area" tags, all down timber greater than 60 inches diameter, bound by the following:

Unit 1, white "Timber Sale Boundary" tags with pink flagging and the 2418A-1 road;

Unit 2, white "Timber Sale Boundary" tags with pink flagging, the 2418A-1, 2418A-2 roads and property line with carsonite posts;

Unit 3, white "Timber Sale Boundary" tags with pink flagging, the 2418-2 road and property line with reprod;

Unit 4, white "Timber Sale Boundary" tags with pink flagging, 2418 road, 2418B road and property line with carsonite posts and pink flagging;

Unit 5, white "Timber Sale Boundary" tags with pink flagging and property line with white carsonite posts and pink flagging;

Unit 6, white "Timber Sale Boundary" tags with pink flagging and property line with white carsonite posts and pink flagging;

ROW 2410C-1, pink flagging;

ROW 2418A1-A, orange "Right of Way" tags and pink flagging; meeting the specifications described below; on parts of Sections 16, and 17 all in Township 10 North, Range 2 East W.M., containing 237 acres, more or less.

MINIMUM BID AND ESTIMATED LOG VOLUMES:

Agreement #	Sort #	Species and Sort Specifications	Average Log Length	Estimated Volume		Tons Per MBF	Minimum Bid Delivered Prices		Total Appraised Value	Bid Deposit
				Mbf	Tons		\$/mbf	\$/Ton		
106329	1	DF 5"-11"	N/A	2736	19152	7		\$0.00	\$0.00	\$0.00
106330	2	DF 12"+	28'	822	4110	5	\$0.00		\$0.00	\$0.00
106331	3	RA 5"+, MA 8"+	N/A	735	5145	7		\$0.00	\$0.00	\$0.00
106332	4	RC 5"+	24'	3	20	6.5	\$0.00		\$0.00	\$0.00
106333	5	WW 5"+	N/A	1143	8001	7		\$0.00	\$0.00	\$0.00
106334	6	Conifer Pulp 2"+	N/A	56	728	13		\$0.00	\$0.00	\$0.00
106335	7	Hardwood	N/A	23	299	13		\$0.00	\$0.00	\$0.00



TIMBER NOTICE OF SALE

		Pulp 2"+							
--	--	----------	--	--	--	--	--	--	--

Totals: 5518 37455 \$0.00

CERTIFICATION: This sale is certified under the Sustainable Forestry Initiative® program Standard (cert no: BVC-SFIFM-018227)

BID METHOD: Sealed Bids UNIT OF MEASURE: MBF Scale/Tonnage Scale

EXPIRATION DATE: December 15, 2024 ALLOCATION: Export Restricted

PAYMENT SECURITY: To be determined by the State as described in Clause P-045.2 of the Purchaser’s Contract.

BIDDING PROCEDURES: A separate sealed bid and envelope must be submitted for each log sort. Prospective Purchasers may bid on any or all log sorts. On the day of sale the Purchaser must bring their bid deposit up to 10% of their total bid price. Complete bidding procedures and auction information may be obtained from the Pacific Cascade Region Office in Castle Rock WA. Phone number (360)577-2025.

TIMBER EXCISE TAX: Purchaser must pay the forest excise taxes associated with the log sorts delivered to them. The tax rate for this sale is 4.2 %. Taxable Stumpage = Total Delivered Value – (Harvest Cost + Estimated Haul Cost + ARRF). For more information contact the Department of Revenue, Forest Tax Section at 1-800-548-8829.

Use the following rates for estimating taxable stumpage:

Harvest Cost = \$0.00 per Ton for sorts 1, 2, 3, 4 and 5 and \$14.00 per Ton for sorts 6 and 7.

Hauling Services Payment Rate per Ton = (Base Rate + Mileage Rate) x (Contractor's hauling bid factor)

Base Rate = \$2.35 per ton

Mileage Rate = ((\$0.16 x C miles) + (\$0.11 x A miles)) x Fuel Index Factor

ARRF = \$0.00 per MBF for sorts 6 and 7 and \$26.00 per MBF for sorts 1, 2, 3, 4 and 5.

Note: To calculate ARRF rates per ton use the tons\mbf conversion factor in the table above.

Long-haul surcharge: An additional haul payment of \$25/mbf net scale for mbf scale sorts or \$4.60/ton for tonnage sorts will be added for delivery destinations in excess of 250 total one-way miles (A miles plus C miles).

CONFIRMATION: Each sort is subject to confirmation following auction. Sorts will not be confirmed until at least 10 days after auction. Final contract award is contingent upon the State’s haul



TIMBER NOTICE OF SALE

cost analysis. Actual haul route may vary and is subject to change at the State's discretion.

SPECIAL REMARKS: The successful Purchaser(s) will be required to purchase logs from the sale area upon delivery to their location specified in the bid submitted. Logs will be delivered to the Purchaser's delivery location by the State's contract harvester. Purchaser is responsible for weighing and scaling costs. All tonnage loads will be weighed and all mbf loads will be scaled at State approved locations. The State reserves the right to determine where logs are authorized to be scaled and weighed.

In Unit 5 and Unit 6 all harvest operations must be completed by 8/31/2024.

For more information regarding this log sort sale visit our web site: <http://www.dnr.wa.gov/programs-and-services/product-sales-and-leasing/timber-sales/timber-auction-packets>. If you have questions call Josh Watten at the Pacific Cascade Region Office at (360)577-2025 or Steve Teitzel at the Product Sales and Leasing Division Office in Olympia at (360)902-1741.

TIMBER SALE MAP

SALE NAME: GHOST TOWN SORTS
AGREEMENT #: 30-104392
TOWNSHIP(S): T10R2E
TRUST(S): Common School and Indemnity (3)

REGION: Pacific Cascade Region
COUNTY(S): Cowlitz
ELEVATION RGE: 1160-2160

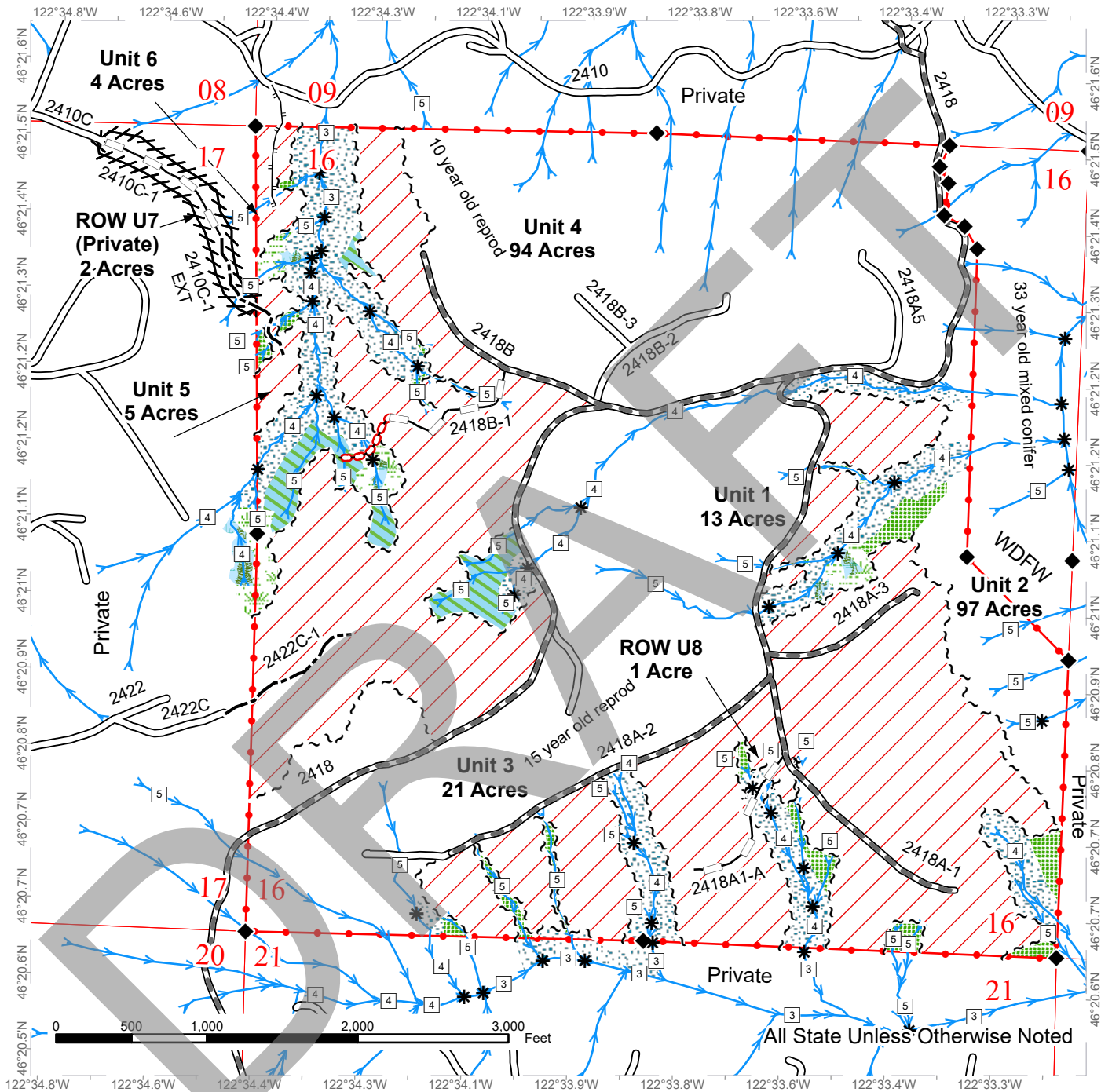

Variable Retention Harvest	Property Line	Optional Construction
Non Tradeable Leave Tree Area	Sale Boundary Tags	Optional Reconstruction
Leave Tree Area	Flag Line	Required Abandonment
Riparian Mgt Zone	Leave Tree Tags	Designated Skid Trail
Forested Wetland	Existing Roads	Streams
Wetland Mgt Zone	Required Pre-Haul Maintenance	Survey Monument



DRIVING MAP

SALE NAME: GHOST TOWN SORTS
AGREEMENT#: None
TOWNSHIP(S): T10R2E
TRUST(S): Common School and Indemnity (3)

REGION: Pacific Cascade Region
COUNTY(S): Cowlitz
ELEVATION RGE: 1160-2160

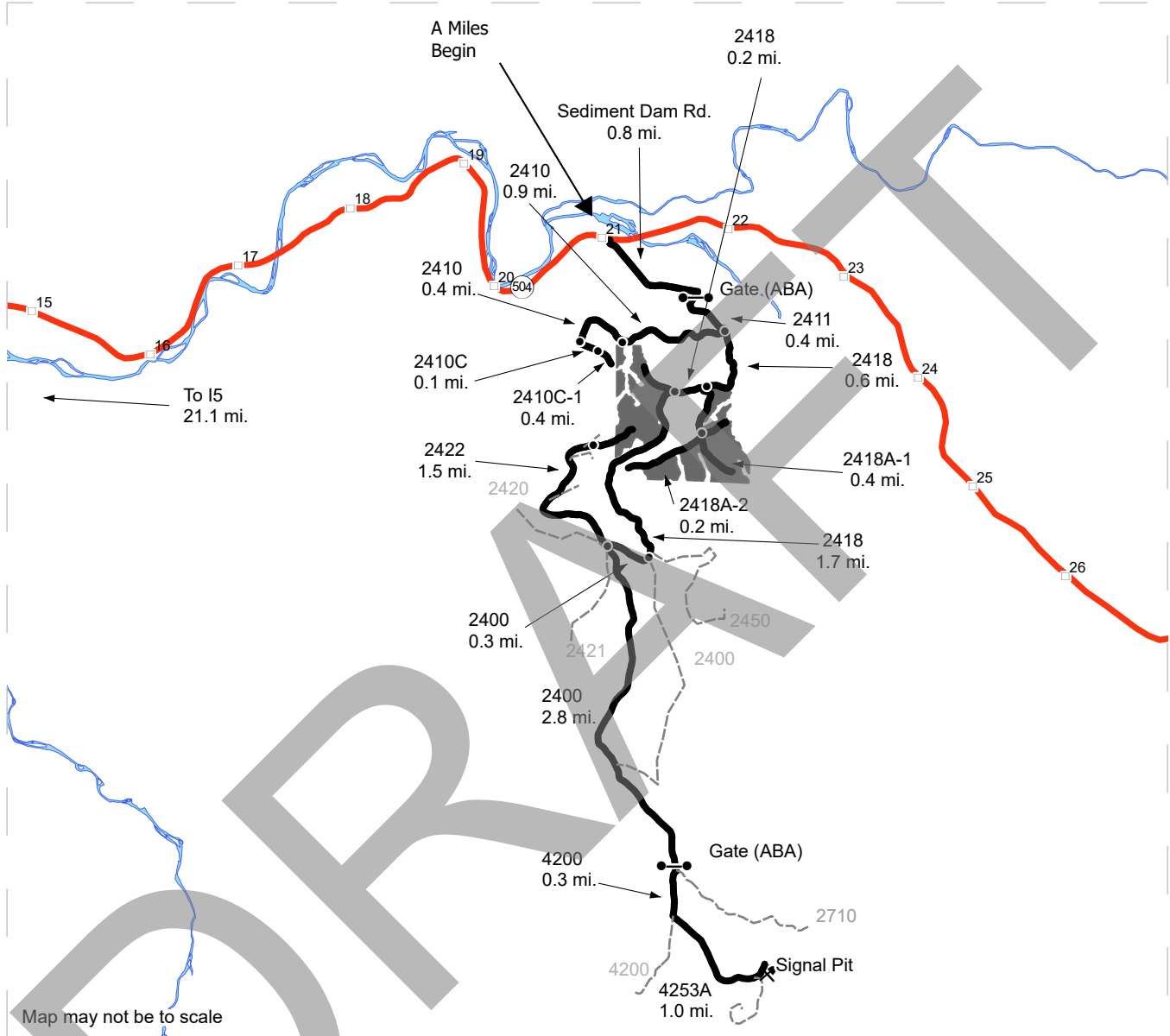

Map may not be to scale

- Timber Sale Unit
- Haul Route
- View Only Route
- Milepost Markers
- Distance Indicator
- Gate
- Rock Pit

DRIVING DIRECTIONS:

From exit 49 off I-5, follow SR 504 east for 21.1 miles. Turn right onto Sediment Dam Rd., after 0.8 miles turn right onto the 2411 road and go through the gate (ABA). Continue on the 2411 for 0.4 miles to the 2411, 2410, and 2418 Junction.

Unit 1: From the Junction continue on the 2418 for 0.6 miles and turn left onto the 2418A-1. The unit will be on the left.

Unit 2: Continue on the 2418A-1 for 0.6 miles. The unit will be on the left.

Unit 3: From Unit 1 continue on the 2418A-1 for 0.4 miles and turn right onto the 2418A-2. Follow for 0.2, Unit 3 will be on the left.

Unit 4: From the 2418/2418A-1 Junction continue on the 2418 for 0.2 miles, Unit 4 will be on the right.

Unit 5: From Unit 6 continue on the 2410 for 0.4 miles and turn left onto the 2410C. After 0.4 miles the reconstruction and new construction of the road will start, walk the centerline to access Unit 5.

Unit 6: From the 2410/2411/2418 Junction turn right onto the 2410 and follow for 0.9 miles. A skid trail accessing Unit 6 will be flagged in orange fagging on the left.

Signal Pit: From Unit 4 continue on the 2418 for 1.7 miles to the 2400 junction. Turn right on the 2400 and continue for 0.3 miles to the 2400, 2421, and 2422 junction. Turn left to stay on the 2400 and follow for 2.8 miles to the gate. At the gate (ABA) continue straight onto the 4200. After 0.3 miles. turn left onto the 4253A and follow for 1 mile into the Signal Pit.



Timber Sale Cruise Report Ghost Town Sorts

Sale Name: GHOST TOWN SORTS

Sale Type: SORT

Region: PACIFIC CASC,PACIFIC CASC

District: ST.HELENS,ST.HELENS

Lead Cruiser: AMDouglas

Other Cruisers: BEWarnstadt, DBuchanan

Cruise Narrative:

Location:

Ghost Town Sorts is located just off Highway 504, 9 miles east of Toutle, WA. Most of the sale has direct access from the 2418 network of forest roads.

Cruise Design:

245 plots were used to tally 1450 trees. 619 trees were measured.

Diameters were recorded to the nearest whole inch. Bole heights were measured to a 5" top or estimated break point.

Trees were segmented into lengths based on a preference for long logs and taking into account location of defect. Preferred length for conifers is 40'. Preferred length for hardwoods is 30'.

Plots that landed in leave tree areas were dropped from the cruise.

Timber Quality:

Ghost town is mostly composed of plantation-style Douglas-fir with some western hemlock and red alder mixed in. Minor spike knots were observed in some trees. Small pockets of fungal-driven mortality are scattered around the sale but are not extensive.

Logging and Stand Conditions:

Sale is mostly flat. Proposed harvesting methods are 91% ground-based, 9% uphill cable. Understory brush is light and conducive to foot travel.

Timber Sale Notice Volume (MBF)

Sp	DBH	Rings/In	Age	MBF Volume by Grade				
				All	2 Saw	3 Saw	4 Saw	Utility
DF	14.8	6.5		3,593	822	2,161	576	35
WH	16.0			1,164	487	502	153	20
RA	11.8			753	37	65	630	21
MA	14.9			5		2	2	0
RC	30.0			3		2	0	
ALL	14.5	6.4		5,518	1,346	2,733	1,362	77

Timber Sale Notice Weight (tons)

Sp	Tons by Grade				
	All	2 Saw	3 Saw	4 Saw	Utility
DF	29,702	6,265	18,109	5,060	268
WH	10,813	3,993	4,984	1,643	193
RA	6,608	283	510	5,668	148
MA	47		20	24	3
RC	30		24	6	
ALL	47,200	10,541	23,646	12,400	612

Timber Sale Overall Cruise Statistics

BA (sq ft/acre)	BA SE (%)	V-BAR (bf/sq ft)	V-BAR SE (%)	Net Vol (bf/acre)	Vol SE (%)
196.3	2.1	116.3	1.0	23,282	2.4

Timber Sale Unit Cruise Design

Unit	Design	Cruise Acres	FMA Acres	N Plots	N Cruise Plots	N Void Plots
GHOST TOWN U1	B1C: VR, 1 BAF (33.61) Measure/ Count Plots, Sighting Ht = 4.5 ft	13.0	13.9	15	9	0
GHOST TOWN U2	B1C: VR, 1 BAF (33.61) Measure/ Count Plots, Sighting Ht = 4.5 ft	97.0	106.4	96	34	0
GHOST TOWN U3	B1C: VR, 1 BAF (33.61) Measure/ Count Plots, Sighting Ht = 4.5 ft	21.0	23.7	21	10	1
GHOST TOWN U4	B1C: VR, 1 BAF (33.61) Measure/ Count Plots, Sighting Ht = 4.5 ft	94.0	105.1	96	33	0
GHOST TOWN U5	B1: VR, 1 BAF (33.61) Measure All, Sighting Ht = 0 ft	5.0	5.6	6	6	0
GHOST TOWN U6	B1: VR, 1 BAF (33.61) Measure All, Sighting Ht = 4.5 ft	4.0	4.7	4	4	0
GHOST TOWN 2418A1 ROW	FX: FR plots (20 tree / acre expansion)	1.0	0.8	2	2	0
2410C-1 ROW	FX: FR plots (20 tree / acre expansion)	2.0		5	5	0
All		237.0	260.2	245	103	1

Timber Sale Log Grade x Sort Summary

Sp	Status	Grade	Sort	Dia	Len	BF Gross	BF Net	Defect %	Tons	MBF Net
DF	LIVE	2 SAW	Domestic	13.6	40	3,189	3,085	3.3	5,558.1	731.2
DF	LIVE	2 SAW	HQ-A	12.6	40	44	44	0.0	79.1	10.5
DF	LIVE	2 SAW	HQ-B	13.5	40	353	337	4.5	628.0	79.9
DF	LIVE	3 SAW	Domestic	8.6	40	9,005	8,682	3.6	17,354.6	2,057.7
DF	LIVE	3 SAW	HQ-B	10.5	40	449	434	3.3	754.5	102.9
DF	LIVE	4 SAW	Domestic	5.2	29	2,530	2,429	4.0	5,059.7	575.6
DF	LIVE	CULL	Cull	5.5	7	137	0	100.0	0.0	0.0
DF	LIVE	UTILITY	Pulp	5.4	21	149	148	0.7	267.7	35.0
MA	LIVE	3 SAW	Domestic	11.5	30	11	10	9.6	19.9	2.4
MA	LIVE	4 SAW	Domestic	5.8	27	10	9	7.4	23.8	2.2
MA	LIVE	UTILITY	Pulp	5.0	12	2	2	0.0	2.9	0.5
RA	LIVE	2 SAW	Domestic	12.1	32	171	158	7.6	282.9	37.4
RA	LIVE	3 SAW	Domestic	10.9	30	294	276	6.3	509.5	65.3
RA	LIVE	4 SAW	Domestic	6.5	29	2,782	2,658	4.5	5,667.8	630.0
RA	LIVE	CULL	Cull	5.4	7	100	0	100.0	0.0	0.0
RA	LIVE	UTILITY	Pulp	5.0	20	88	88	0.0	148.0	20.7
RC	LIVE	3 SAW	Domestic	18.1	40	15	11	30.1	24.0	2.5
RC	LIVE	4 SAW	Domestic	8.9	34	2	1	34.7	6.0	0.3
WH	LIVE	2 SAW	Domestic	14.6	40	2,179	2,057	5.6	3,993.0	487.5
WH	LIVE	3 SAW	Domestic	8.8	40	2,196	2,120	3.4	4,983.8	502.4
WH	LIVE	4 SAW	Domestic	5.4	29	672	648	3.6	1,643.2	153.5
WH	LIVE	CULL	Cull	5.7	6	47	0	100.0	0.0	0.0
WH	LIVE	UTILITY	Pulp	6.4	26	87	86	0.6	193.2	20.4

Timber Sale Log Sort x Diameter Bin Summary

Sp	Bin	Status	Sort	Dia	Len	BF Net	Defect %	Tons	MBF Net
DF	< 5	LIVE	Cull	4.9	10	0	100.0	0.0	0.0
DF	5 - 7	LIVE	Pulp	5.4	21	144	0.7	257.8	34.1
DF	5 - 7	LIVE	Cull	5.5	7	0	100.0	0.0	0.0
DF	5 - 7	LIVE	Domestic	5.7	32	4,628	3.6	9,631.0	1,096.7
DF	8 - 11	LIVE	Cull	8.0	7	0	100.0	0.0	0.0
DF	8 - 11	LIVE	Pulp	8.3	13	4	0.0	9.8	0.9
DF	8 - 11	LIVE	Domestic	9.6	40	6,483	3.7	12,783.3	1,536.6
DF	8 - 11	LIVE	HQ-B	10.5	40	434	3.3	754.5	102.9
DF	12 - 19	LIVE	HQ-A	12.6	40	44	0.0	79.1	10.5
DF	12 - 19	LIVE	Domestic	13.5	40	3,085	3.3	5,558.1	731.2

Sp	Bin	Status	Sort	Dia	Len	BF Net	Defect %	Tons	MBF Net
DF	12 - 19	LIVE	HQ-B	13.5	40	337	4.5	628.0	79.9
MA	5 - 7	LIVE	Pulp	5.0	12	2	0.0	2.9	0.5
MA	5 - 7	LIVE	Domestic	6.7	29	9	7.4	23.8	2.2
MA	8 - 11	LIVE	Domestic	11.5	30	10	9.6	19.9	2.4
RA	5 - 7	LIVE	Cull	5.0	6	0	100.0	0.0	0.0
RA	5 - 7	LIVE	Pulp	5.0	20	88	0.0	148.0	20.7
RA	5 - 7	LIVE	Domestic	5.7	30	1,726	4.2	3,583.0	409.2
RA	8 - 11	LIVE	Domestic	9.3	30	1,207	5.2	2,594.3	286.2
RA	8 - 11	LIVE	Cull	9.7	10	0	100.0	0.0	0.0
RA	12 - 19	LIVE	Domestic	12.1	31	158	7.6	282.9	37.4
RC	8 - 11	LIVE	Domestic	8.9	34	1	34.7	6.0	0.3
RC	12 - 19	LIVE	Domestic	18.1	40	11	30.1	24.0	2.5
WH	5 - 7	LIVE	Cull	5.5	6	0	100.0	0.0	0.0
WH	5 - 7	LIVE	Pulp	5.6	22	43	1.1	105.2	10.2
WH	5 - 7	LIVE	Domestic	5.8	32	1,246	2.5	3,102.2	295.2
WH	8 - 11	LIVE	Domestic	9.8	40	1,499	4.2	3,479.0	355.3
WH	8 - 11	LIVE	Pulp	10.5	40	43	0.0	88.0	10.3
WH	12 - 19	LIVE	Domestic	14.6	40	2,080	5.6	4,038.8	492.9

Cruise Unit Report GHOST TOWN U1

Unit Sale Notice Volume (MBF): GHOST TOWN U1

Sp	DBH	Rings/In	Age	MBF Volume by Grade				
				All	2 Saw	3 Saw	4 Saw	Utility
WH	11.9			120	8	73	39	
DF	12.2			53	4	30	19	
RA	11.1			50	4	4	43	
MA	12.0			2			2	0
ALL	11.7			225	16	107	102	0

Unit Cruise Design: GHOST TOWN U1

Design	Cruise Acres	FMA Acres	N Plots	N Cruise Plots	N Void Plots
B1C: VR, 1 BAF (33.61) Measure/Count Plots, Sighting Ht = 4.5 ft	13.0	13.9	15	9	0

Unit Cruise Summary: GHOST TOWN U1

Sp	Cruised Trees	All Trees	Trees/Plot	Ring-Count Trees
WH	13	32	2.1	0
DF	10	17	1.1	0
RA	13	19	1.3	0
MA	1	1	0.1	0
ALL	37	69	4.6	0

Unit Cruise Statistics: GHOST TOWN U1

Sp	BA (sq ft/acre)	BA CV (%)	BA SE (%)	V-BAR (bf/sq ft)	V-BAR CV (%)	V-BAR SE (%)	Net Vol (bf/acre)	Vol CV (%)	Vol SE (%)
WH	71.7	90.1	23.3	128.4	18.5	5.1	9,203	92.0	23.8
DF	38.1	152.3	39.3	107.3	8.8	2.8	4,087	152.6	39.4
RA	42.6	124.7	32.2	90.4	26.9	7.5	3,850	127.6	33.1
MA	2.2	387.3	100.0	73.8	0.0	0.0	165	387.3	100.0
ALL	154.6	38.4	9.9	111.9	23.7	3.9	17,306	45.1	10.6

Unit Summary: GHOST TOWN U1

Sp	Status	Rx	N	D	DBH	BL	THT	BF Gross	BF Net	Defect %	TPA	BA	RD	MBF Net
DF	LIVE	CUT	10	ALL	12.0	54	84	4,136	4,087	1.2	48.5	38.1	11.0	53.1
MA	LIVE	CUT	1	ALL	12.0	44	59	174	165	4.9	2.9	2.2	0.6	2.2
RA	LIVE	CUT	13	ALL	11.1	48	70	4,130	3,850	6.8	63.4	42.6	12.8	50.0
WH	LIVE	CUT	13	ALL	11.9	62	88	9,376	9,203	1.8	92.8	71.7	20.8	119.6
ALL	LIVE	CUT	37	ALL	11.7	56	81	17,816	17,306	2.9	207.6	154.6	45.2	225.0
ALL	ALL	ALL	37	ALL	11.7	56	81	17,816	17,306	2.9	207.6	154.6	45.2	225.0

DRAFT

Cruise Unit Report GHOST TOWN U2

Unit Sale Notice Volume (MBF): GHOST TOWN U2

Sp	DBH	Rings/In	Age	MBF Volume by Grade				
				All	2 Saw	3 Saw	4 Saw	Utility
DF	13.5	5.3		901	144	550	185	22
RA	12.0			510	32	40	417	20
WH	14.6			294	49	186	52	8
ALL	13.2	5.3		1,705	224	776	655	50

Unit Cruise Design: GHOST TOWN U2

Design	Cruise Acres	FMA Acres	N Plots	N Cruise Plots	N Void Plots
B1C: VR, 1 BAF (33.61) Measure/Count Plots, Sighting Ht = 4.5 ft	97.0	106.4	96	34	0

Unit Cruise Summary: GHOST TOWN U2

Sp	Cruised Trees	All Trees	Trees/Plot	Ring-Count Trees
DF	107	259	2.7	2
RA	46	166	1.7	0
WH	32	85	0.9	0
ALL	185	510	5.3	2

Unit Cruise Statistics: GHOST TOWN U2

Sp	BA (sq ft/acre)	BA CV (%)	BA SE (%)	V-BAR (bf/sq ft)	V-BAR CV (%)	V-BAR SE (%)	Net Vol (bf/acre)	Vol CV (%)	Vol SE (%)
DF	90.7	95.2	9.7	102.5	27.3	2.6	9,290	99.0	10.1
RA	58.1	111.5	11.4	90.4	24.4	3.6	5,256	114.1	11.9
WH	29.8	152.7	15.6	101.9	33.6	5.9	3,032	156.4	16.7
ALL	178.6	36.1	3.7	98.4	28.6	2.1	17,578	46.0	4.2

Unit Summary: GHOST TOWN U2

Sp	Status	Rx	N	D	DBH	BL	THT	BF Gross	BF Net	Defect %	TPA	BA	RD	MBF Net
DF	LIVE	CUT	107	ALL	13.5	57	78	9,715	9,290	4.4	91.2	90.7	24.7	901.2
RA	LIVE	CUT	46	ALL	12.0	50	70	5,643	5,256	6.9	74.0	58.1	16.8	509.8

Sp	Status	Rx	N	D	DBH	BL	THT	BF Gross	BF Net	Defect %	TPA	BA	RD	MBF Net
WH	LIVE	CUT	32	ALL	14.6	57	74	3,116	3,032	2.7	25.6	29.8	7.8	294.1
ALL	LIVE	CUT	185	ALL	13.1	54	75	18,474	17,578	4.8	190.8	178.6	49.2	1,705.1
ALL	ALL	ALL	185	ALL	13.1	54	75	18,474	17,578	4.8	190.8	178.6	49.2	1,705.1

DRAFT

Cruise Unit Report GHOST TOWN U3

Unit Sale Notice Volume (MBF): GHOST TOWN U3

Sp	DBH	Rings/In	Age	MBF Volume by Grade			
				All	3 Saw	4 Saw	Utility
DF	12.8	6.0		195	148	45	3
RA	10.6			125		125	
WH	12.0			31	24	7	
ALL	11.6	6.0		351	171	177	3

Unit Cruise Design: GHOST TOWN U3

Design	Cruise Acres	FMA Acres	N Plots	N Cruise Plots	N Void Plots
B1C: VR, 1 BAF (33.61) Measure/Count Plots, Sighting Ht = 4.5 ft	21.0	23.7	21	10	1

Unit Cruise Summary: GHOST TOWN U3

Sp	Cruised Trees	All Trees	Trees/Plot	Ring-Count Trees
DF	26	56	2.7	1
RA	24	42	2.0	0
WH	6	10	0.5	0
ALL	56	108	5.1	1

Unit Cruise Statistics: GHOST TOWN U3

Sp	BA (sq ft/acre)	BA CV (%)	BA SE (%)	V-BAR (bf/sq ft)	V-BAR CV (%)	V-BAR SE (%)	Net Vol (bf/acre)	Vol CV (%)	Vol SE (%)
DF	89.6	73.4	16.0	103.7	21.6	4.2	9,292	76.5	16.6
RA	67.2	100.0	21.8	88.9	21.3	4.3	5,974	102.2	22.3
WH	16.0	142.7	31.1	91.5	32.3	13.2	1,465	146.3	33.8
ALL	172.9	37.5	8.2	96.8	23.3	3.1	16,730	44.2	8.8

Unit Summary: GHOST TOWN U3

Sp	Status	Rx	N	D	DBH	BL	THT	BF Gross	BF Net	Defect %	TPA	BA	RD	MBF Net
DF	LIVE	CUT	26	ALL	12.8	59	81	9,766	9,292	4.9	100.3	89.6	25.1	195.1
RA	LIVE	CUT	24	ALL	10.6	48	70	6,629	5,974	9.9	109.7	67.2	20.6	125.4

Sp	Status	Rx	N	D	DBH	BL	THT	BF Gross	BF Net	Defect %	TPA	BA	RD	MBF Net
WH	LIVE	CUT	6	ALL	12.0	50	67	1,518	1,465	3.5	20.4	16.0	4.6	30.8
ALL	LIVE	CUT	56	ALL	11.7	53	74	17,913	16,730	6.6	230.4	172.9	50.3	351.3
ALL	ALL	ALL	56	ALL	11.7	53	74	17,913	16,730	6.6	230.4	172.9	50.3	351.3

DRAFT

Cruise Unit Report GHOST TOWN U4

Unit Sale Notice Volume (MBF): GHOST TOWN U4

Sp	DBH	Rings/In	Age	MBF Volume by Grade				
				All	2 Saw	3 Saw	4 Saw	Utility
DF	15.5	7.0		2,247	637	1,304	296	10
WH	17.5			707	428	213	54	13
RA	12.9			34		10	23	
MA	17.0			3		2	1	
RC	30.0			3		2	0	
ALL	15.8	7.0		2,993	1,065	1,532	373	23

Unit Cruise Design: GHOST TOWN U4

Design	Cruise Acres	FMA Acres	N Plots	N Cruise Plots	N Void Plots
B1C: VR, 1 BAF (33.61) Measure/Count Plots, Sighting Ht = 4.5 ft	94.0	105.0	96	33	0

Unit Cruise Summary: GHOST TOWN U4

Sp	Cruised Trees	All Trees	Trees/Plot	Ring-Count Trees
DF	173	496	5.2	1
WH	52	148	1.5	0
RA	9	12	0.1	0
MA	1	1	0.0	0
RC	1	1	0.0	0
ALL	236	658	6.9	1

Unit Cruise Statistics: GHOST TOWN U4

Sp	BA (sq ft/acre)	BA CV (%)	BA SE (%)	V-BAR (bf/sq ft)	V-BAR CV (%)	V-BAR SE (%)	Net Vol (bf/acre)	Vol CV (%)	Vol SE (%)
DF	173.7	47.5	4.9	137.6	18.6	1.4	23,902	51.1	5.1
WH	51.8	144.6	14.8	145.2	24.6	3.4	7,525	146.6	15.1
RA	4.2	422.5	43.1	85.2	35.1	11.7	358	424.0	44.7
MA	0.4	979.8	100.0	87.5	0.0	0.0	31	979.8	100.0
RC	0.4	979.8	100.0	85.8	0.0	0.0	30	979.8	100.0
ALL	230.4	29.0	3.0	138.2	22.0	1.4	31,845	36.4	3.3

Unit Summary: GHOST TOWN U4

Sp	Status	Rx	N	D	DBH	BL	THT	BF Gross	BF Net	Defect %	TPA	BA	RD	MBF Net
DF	LIVE	CUT	173	ALL	15.6	76	101	25,037	23,902	4.5	130.8	173.7	44.0	2,246.8
MA	LIVE	CUT	1	ALL	17.0	58	71	34	31	9.8	0.2	0.4	0.1	2.9
RA	LIVE	CUT	9	ALL	12.9	53	69	406	358	11.8	4.6	4.2	1.2	33.6
RC	LIVE	CUT	1	ALL	30.0	76	96	43	30	30.6	0.1	0.4	0.1	2.8
WH	LIVE	CUT	52	ALL	17.5	72	95	8,075	7,525	6.8	31.0	51.8	12.4	707.3
ALL	LIVE	CUT	236	ALL	15.9	75	99	33,596	31,845	5.2	166.7	230.4	57.7	2,993.5
ALL	ALL	ALL	236	ALL	15.9	75	99	33,596	31,845	5.2	166.7	230.4	57.7	2,993.5

DRAFT

Cruise Unit Report GHOST TOWN U5

Unit Sale Notice Volume (MBF): GHOST TOWN U5

Sp	DBH	Rings/In	Age	MBF Volume by Grade			
				All	2 Saw	3 Saw	4 Saw
DF	14.1			97	9	70	18
WH	15.6			8	3	4	1
ALL	14.2			105	12	73	19

Unit Cruise Design: GHOST TOWN U5

Design	Cruise Acres	FMA Acres	N Plots	N Cruise Plots	N Void Plots
B1: VR, 1 BAF (33.61) Measure All, Sighting Ht = 0 ft	5.0	5.6	6	6	0

Unit Cruise Summary: GHOST TOWN U5

Sp	Cruised Trees	All Trees	Trees/Plot	Ring-Count Trees
DF	24	24	4.0	0
WH	2	2	0.3	0
ALL	26	26	4.3	0

Unit Cruise Statistics: GHOST TOWN U5

Sp	BA (sq ft/acre)	BA CV (%)	BA SE (%)	V-BAR (bf/sq ft)	V-BAR CV (%)	V-BAR SE (%)	Net Vol (bf/acre)	Vol CV (%)	Vol SE (%)
DF	134.4	54.8	22.4	144.4	13.9	2.8	19,408	56.5	22.5
WH	11.2	244.9	100.0	141.3	1.3	0.9	1,583	245.0	100.0
ALL	145.6	34.7	14.2	144.1	13.4	2.6	20,991	37.2	14.4

Unit Summary: GHOST TOWN U5

Sp	Status	Rx	N	D	DBH	BL	THT	BF Gross	BF Net	Defect %	TPA	BA	RD	MBF Net
DF	LIVE	CUT	24	ALL	14.1	79	109	19,985	19,408	2.9	124.0	134.4	35.8	97.0
WH	LIVE	CUT	2	ALL	15.6	83	108	1,641	1,583	3.5	8.4	11.2	2.8	7.9
ALL	LIVE	CUT	26	ALL	14.2	79	109	21,626	20,991	2.9	132.4	145.6	38.6	105.0
ALL	ALL	ALL	26	ALL	14.2	79	109	21,626	20,991	2.9	132.4	145.6	38.6	105.0

Cruise Unit Report GHOST TOWN U6

Unit Sale Notice Volume (MBF): GHOST TOWN U6

Sp	DBH	Rings/In	Age	MBF Volume by Grade			
				All	2 Saw	3 Saw	4 Saw
DF	16.2			82	23	48	10
ALL	16.2			82	23	48	10

Unit Cruise Design: GHOST TOWN U6

Design	Cruise Acres	FMA Acres	N Plots	N Cruise Plots	N Void Plots
B1: VR, 1 BAF (33.61) Measure All, Sighting Ht = 4.5 ft	4.0	4.7	4	4	0

Unit Cruise Summary: GHOST TOWN U6

Sp	Cruised Trees	All Trees	Trees/Plot	Ring-Count Trees
DF	20	20	5.0	0
ALL	20	20	5.0	0

Unit Cruise Statistics: GHOST TOWN U6

Sp	BA (sq ft/acre)	BA CV (%)	BA SE (%)	V-BAR (bf/sq ft)	V-BAR CV (%)	V-BAR SE (%)	Net Vol (bf/acre)	Vol CV (%)	Vol SE (%)
DF	168.1	32.7	16.3	122.1	14.5	3.3	20,515	35.7	16.7
ALL	168.1	32.7	16.3	122.1	14.5	3.3	20,515	35.7	16.7

Unit Summary: GHOST TOWN U6

Sp	Status	Rx	N	D	DBH	BL	THT	BF Gross	BF Net	Defect %	TPA	BA	RD	MBF Net
DF	LIVE	CUT	20	ALL	16.2	74	95	21,383	20,515	4.1	117.4	168.1	41.8	82.1
ALL	LIVE	CUT	20	ALL	16.2	74	95	21,383	20,515	4.1	117.4	168.1	41.8	82.1
ALL	ALL	ALL	20	ALL	16.2	74	95	21,383	20,515	4.1	117.4	168.1	41.8	82.1

Cruise Unit Report GHOST TOWN 2418A1 ROW

Unit Sale Notice Volume (MBF): GHOST TOWN 2418A1 ROW

Sp	DBH	Rings/In	Age	MBF Volume by Grade			
				All	2 Saw	3 Saw	4 Saw
RA	9.9			9		1	8
DF	15.0			8	2	5	1
WH	15.5			3		3	1
ALL	12.0			21	2	9	9

Unit Cruise Design: GHOST TOWN 2418A1 ROW

Design	Cruise Acres	FMA Acres	N Plots	N Cruise Plots	N Void Plots
FX: FR plots (20 tree / acre expansion)	1.0	0.8	2	2	0

Unit Cruise Summary: GHOST TOWN 2418A1 ROW

Sp	Cruised Trees	All Trees	Trees/Plot	Ring-Count Trees
RA	13	13	6.5	0
DF	5	5	2.5	0
WH	2	2	1.0	0
ALL	20	20	10.0	0

Unit Cruise Statistics: GHOST TOWN 2418A1 ROW

Sp	BA (sq ft/acre)	BA CV (%)	BA SE (%)	V-BAR (bf/sq ft)	V-BAR CV (%)	V-BAR SE (%)	Net Vol (bf/acre)	Vol CV (%)	Vol SE (%)
RA	70.1	47.7	33.7	125.6	19.0	5.3	8,800	51.3	34.1
DF	61.2	141.4	100.0	136.2	10.4	4.6	8,340	141.8	100.1
WH	26.2	9.1	6.4	130.8	10.4	7.3	3,430	13.8	9.8
ALL	157.6	32.3	22.8	130.5	15.7	3.5	20,570	35.9	23.1

Unit Summary: GHOST TOWN 2418A1 ROW

Sp	Status	Rx	N	D	DBH	BL	THT	BF Gross	BF Net	Defect %	TPA	BA	RD	MBF Net
DF	LIVE	CUT	5	ALL	15.0	74	99	8,510	8,340	2.0	49.9	61.2	15.8	8.3
RA	LIVE	CUT	13	ALL	9.9	53	88	9,250	8,800	4.9	131.1	70.1	22.3	8.8
WH	LIVE	CUT	2	ALL	15.5	71	88	3,670	3,430	6.5	20.0	26.2	6.7	3.4
ALL	LIVE	CUT	20	ALL	12.0	60	91	21,430	20,570	4.0	201.0	157.6	44.8	20.6

Sp	Status	Rx	N	D	DBH	BL	THT	BF Gross	BF Net	Defect %	TPA	BA	RD	MBF Net
ALL	ALL	ALL	20	ALL	12.0	60	91	21,430	20,570	4.0	201.0	157.6	44.8	20.6

DRAFT

Cruise Unit Report 2410C-1 ROW

Unit Sale Notice Volume (MBF): 2410C-1 ROW

Sp	DBH	Rings/In	Age	MBF Volume by Grade				
				All	2 Saw	3 Saw	4 Saw	Utility
RA	14.3			26	1	10	14	1
DF	14.1			9	2	5	2	
WH	12.0			1		1		0
ALL	14.2			36	3	16	16	1

Unit Cruise Design: 2410C-1 ROW

Design	Cruise Acres	FMA Acres	N Plots	N Cruise Plots	N Void Plots
FX: FR plots (20 tree / acre expansion)	2.0		5	5	0

Unit Cruise Summary: 2410C-1 ROW

Sp	Cruised Trees	All Trees	Trees/Plot	Ring-Count Trees
RA	29	29	5.8	0
DF	9	9	1.8	0
WH	1	1	0.2	0
ALL	39	39	7.8	0

Unit Cruise Statistics: 2410C-1 ROW

Sp	BA (sq ft/acre)	BA CV (%)	BA SE (%)	V-BAR (bf/sq ft)	V-BAR CV (%)	V-BAR SE (%)	Net Vol (bf/acre)	Vol CV (%)	Vol SE (%)
RA	128.5	18.2	8.1	99.9	22.3	4.1	12,836	28.8	9.1
DF	39.0	91.3	40.8	117.8	14.8	4.9	4,596	92.5	41.1
WH	3.1	223.6	100.0	109.5	0.0	0.0	344	223.6	100.0
ALL	170.7	29.0	13.0	104.2	20.7	3.3	17,776	35.7	13.4

Unit Summary: 2410C-1 ROW

Sp	Status	Rx	N	D	DBH	BL	THT	BF Gross	BF Net	Defect %	TPA	BA	RD	MBF Net
DF	LIVE	CUT	9	ALL	14.1	67	91	4,780	4,596	3.8	36.0	39.0	10.4	9.2
RA	LIVE	CUT	29	ALL	14.3	58	75	13,104	12,836	2.0	115.2	128.5	34.0	25.7
WH	LIVE	CUT	1	ALL	12.0	55	75	344	344	0.0	4.0	3.1	0.9	0.7
ALL	LIVE	CUT	39	ALL	14.2	60	79	18,228	17,776	2.5	155.2	170.7	45.3	35.6

Sp	Status	Rx	N	D	DBH	BL	THT	BF Gross	BF Net	Defect %	TPA	BA	RD	MBF Net
ALL	ALL	ALL	39	ALL	14.2	60	79	18,228	17,776	2.5	155.2	170.7	45.3	35.6

DRAFT

ROAD PLAN MAP

SALE NAME: GHOST TOWN SORTS
AGREEMENT#: 30-104392
TOWNSHIP(S): T10R2E
TRUST(S): Common School and Indemnity (3)

REGION: Pacific Cascade Region
COUNTY(S): Cowlitz
ELEVATION RGE: 1160-2160

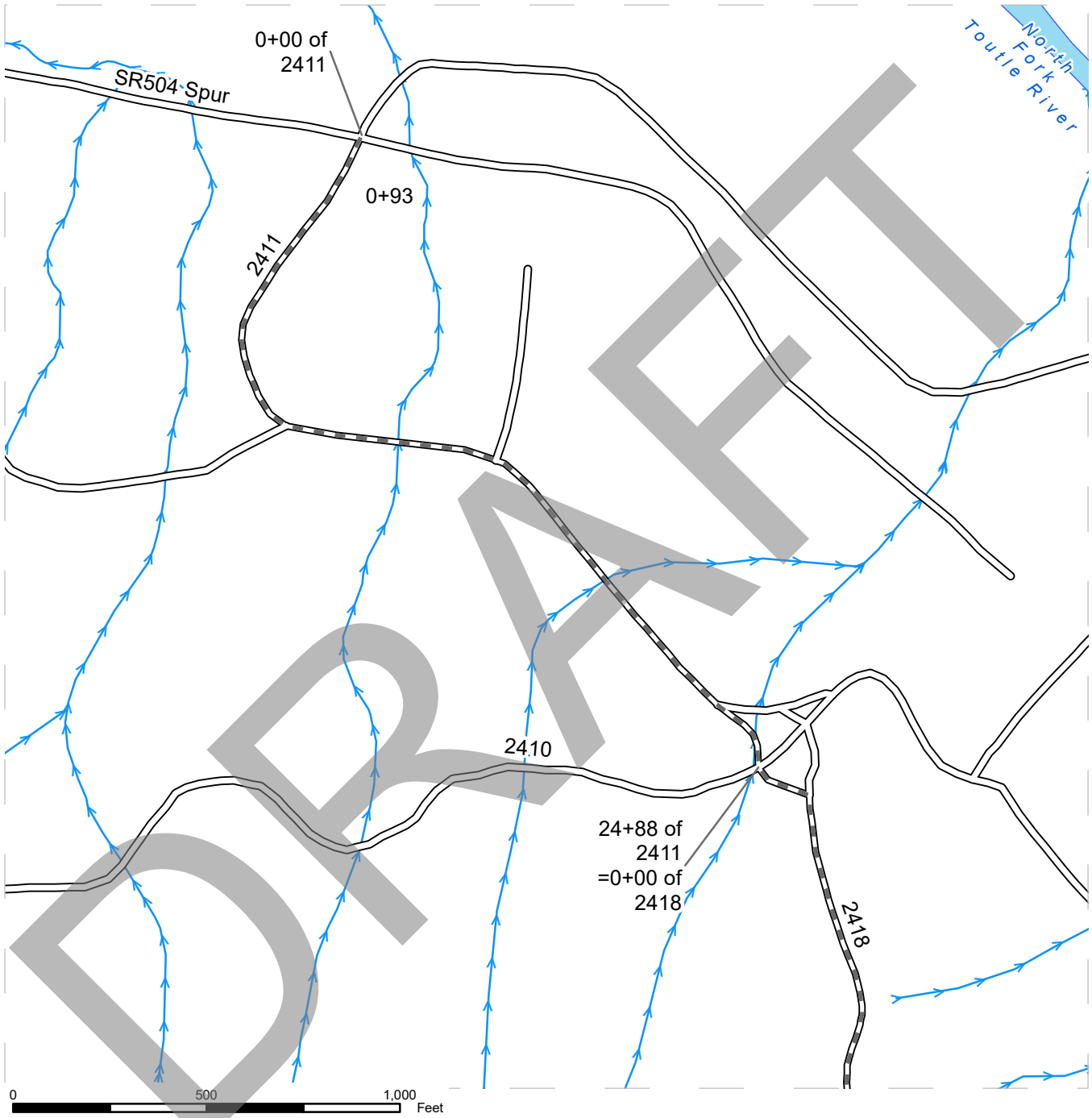

Legend:

- Existing Roads
- Required Pre-Haul Maintenance
- Streams

North Arrow

ROAD PLAN MAP

SALE NAME: GHOST TOWN SORTS
AGREEMENT#: 30-104392
TOWNSHIP(S): T10R2E
TRUST(S): Common School and Indemnity (3)

REGION: Pacific Cascade Region
COUNTY(S): Cowlitz
ELEVATION RGE: 1160-2160

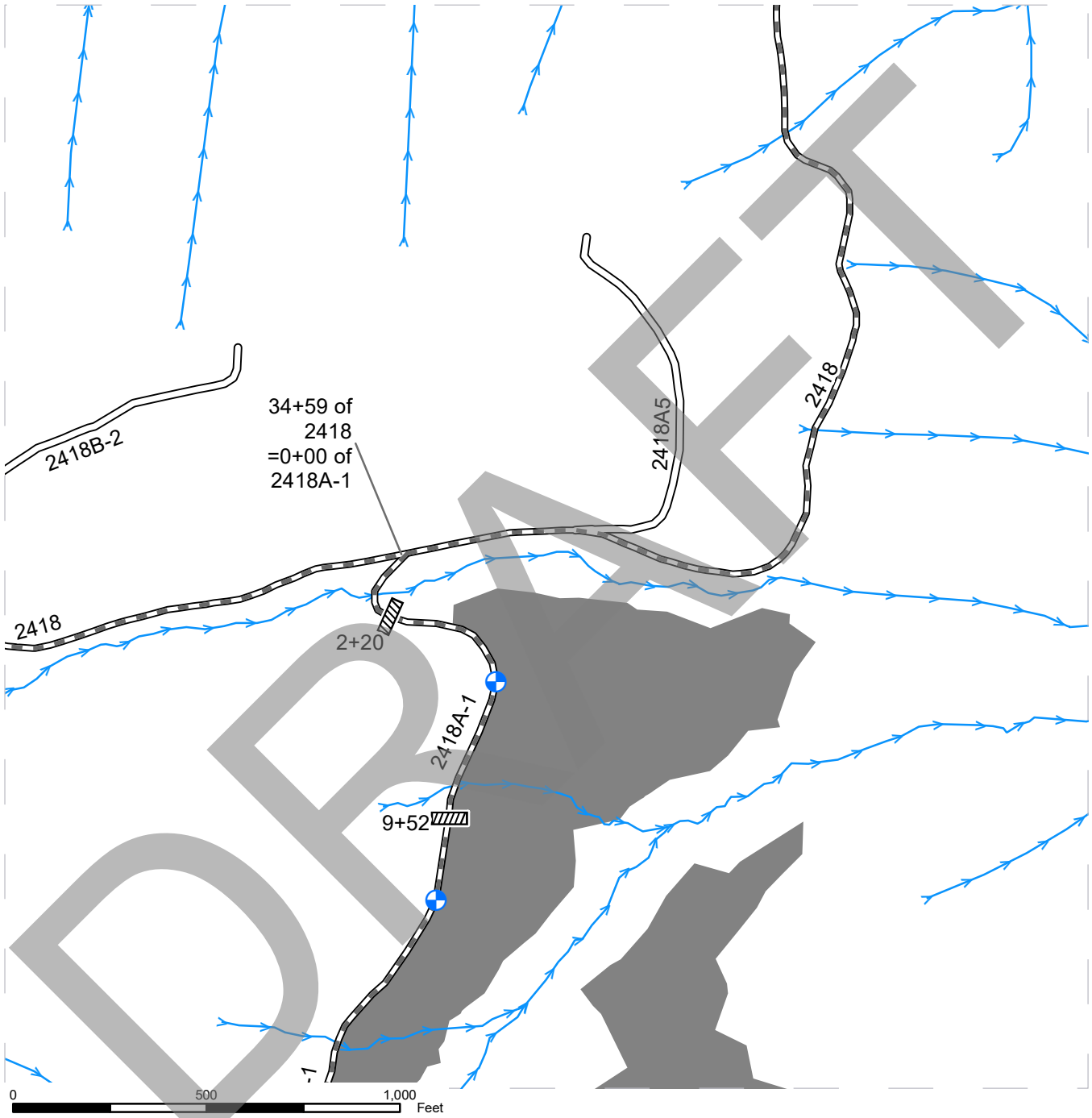

Existing Roads	Culvert	Harvest Unit
Required Pre-Haul Maintenance	Landing - Proposed	Streams



ROAD PLAN MAP

SALE NAME: GHOST TOWN SORTS
AGREEMENT#: 30-104392
TOWNSHIP(S): T10R2E
TRUST(S): Common School and Indemnity (3)

REGION: Pacific Cascade Region
COUNTY(S): Cowlitz
ELEVATION RGE: 1160-2160

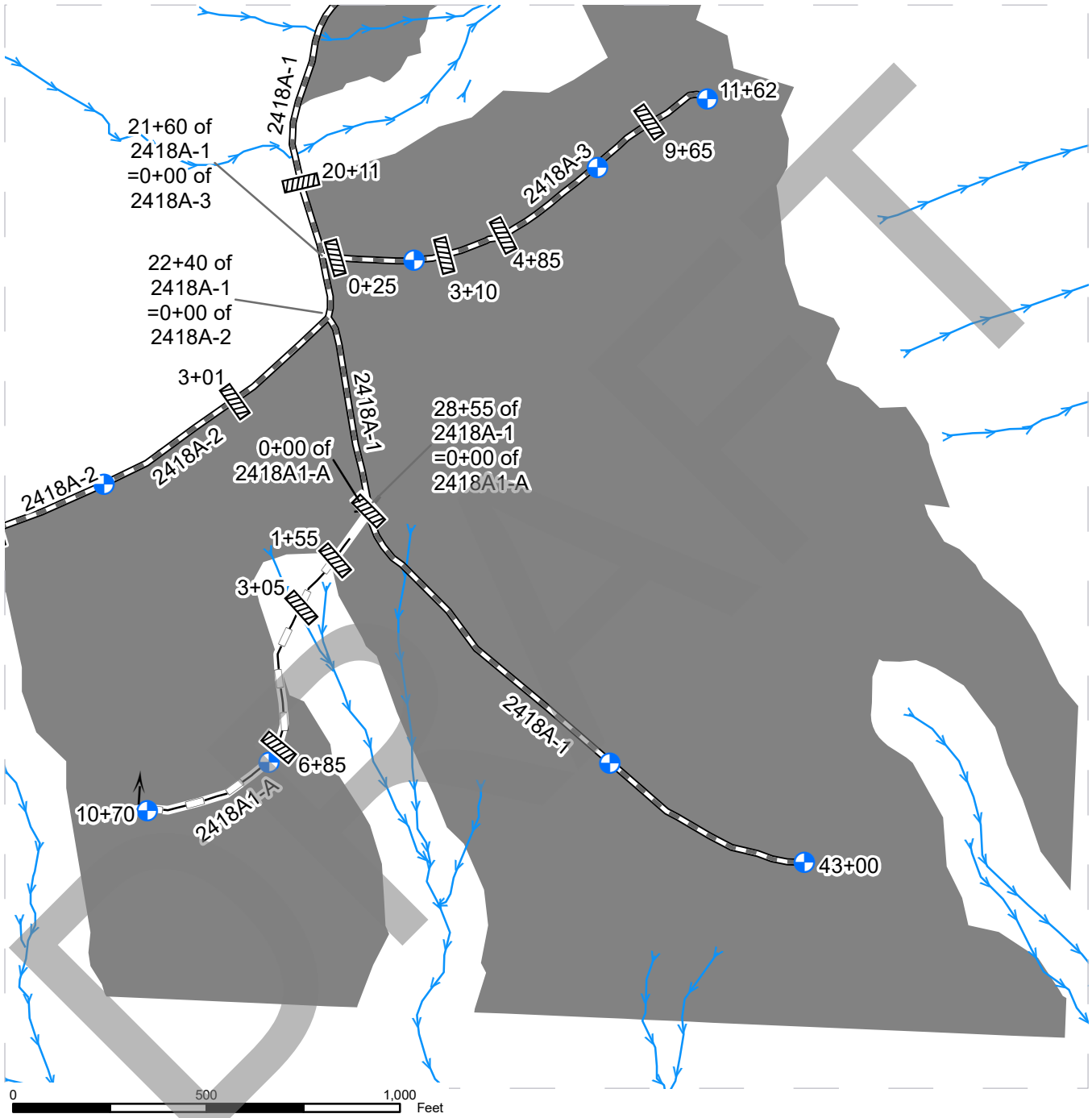

Required Pre-Haul Maintenance	Ditchout	Harvest Unit
Optional Reconstruction	Culvert	Streams
	Landing - Proposed	



ROAD PLAN MAP

SALE NAME: GHOST TOWN SORTS
AGREEMENT#: 30-104392
TOWNSHIP(S): T10R2E
TRUST(S): Common School and Indemnity (3)

REGION: Pacific Cascade Region
COUNTY(S): Cowlitz
ELEVATION RGE: 1160-2160

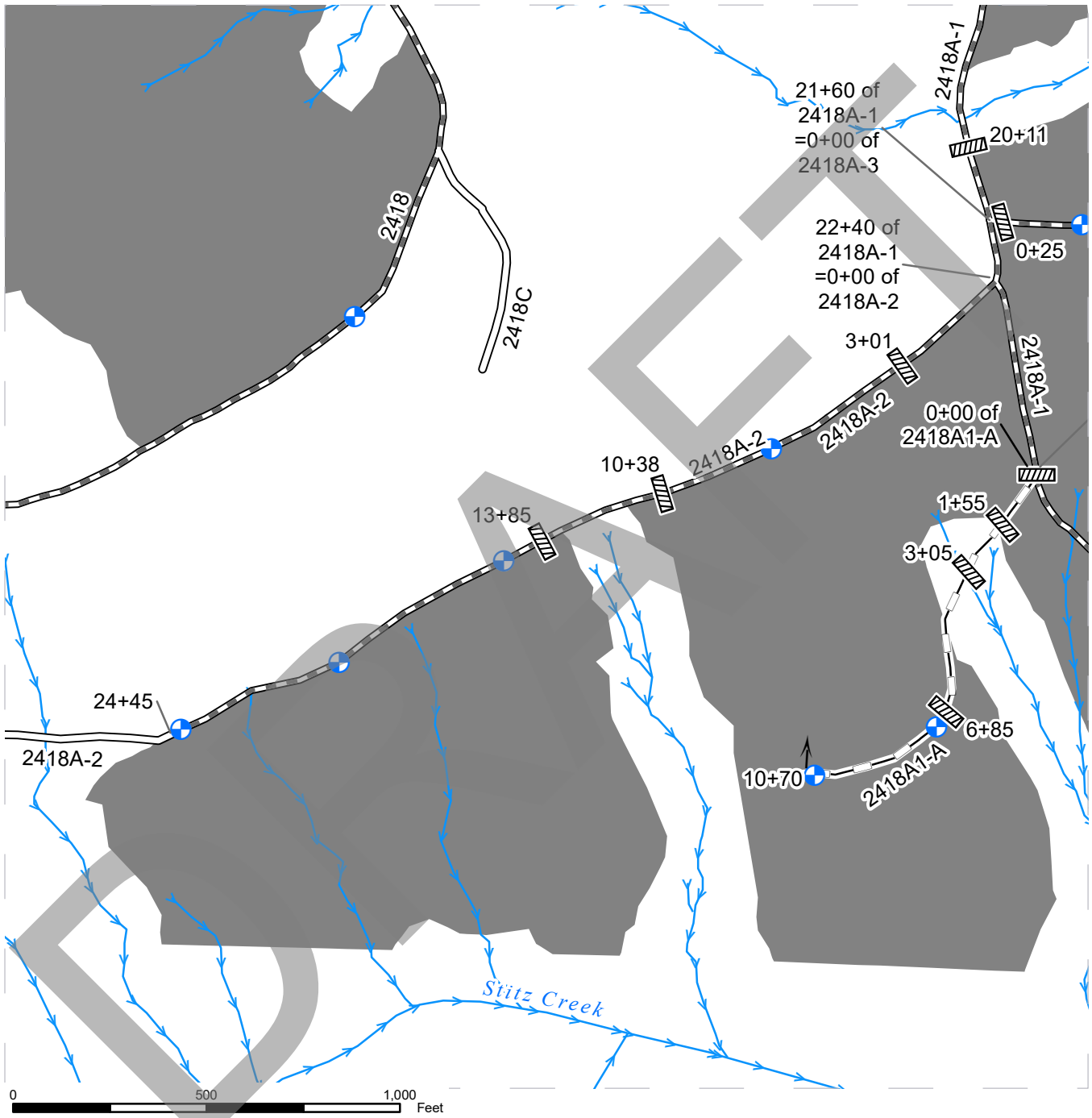

Existing Roads	Ditchout	Harvest Unit
Required Pre-Haul Maintenance	Culvert	Streams
Optional Reconstruction	Landing - Proposed	



ROAD PLAN MAP

SALE NAME: GHOST TOWN SORTS
AGREEMENT#: 30-104392
TOWNSHIP(S): T10R2E
TRUST(S): Common School and Indemnity (3)

REGION: Pacific Cascade Region
COUNTY(S): Cowlitz
ELEVATION RGE: 1160-2160

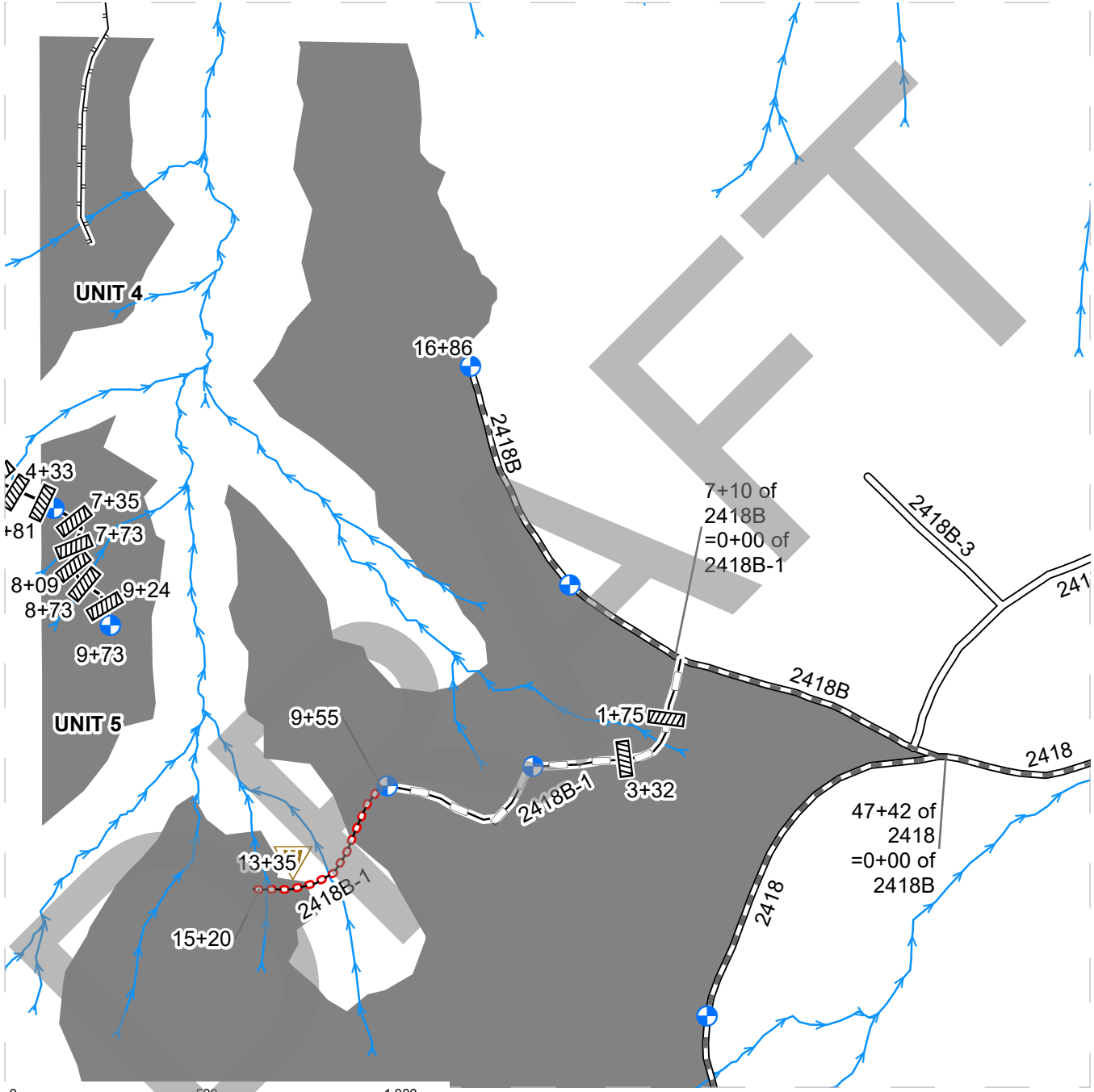

Existing Roads	Culvert	Harvest Unit
Required Pre-Haul Maintenance	Landing - Proposed	Streams
Optional Construction	Waste Area	
Optional Reconstruction		
Required Abandonment		
Designated Skid Trail		



ROAD PLAN MAP

SALE NAME: GHOST TOWN SORTS
AGREEMENT#: 30-104392
TOWNSHIP(S): T10R2E
TRUST(S): Common School and Indemnity (3)

REGION: Pacific Cascade Region
COUNTY(S): Cowlitz
ELEVATION RGE: 1160-2160

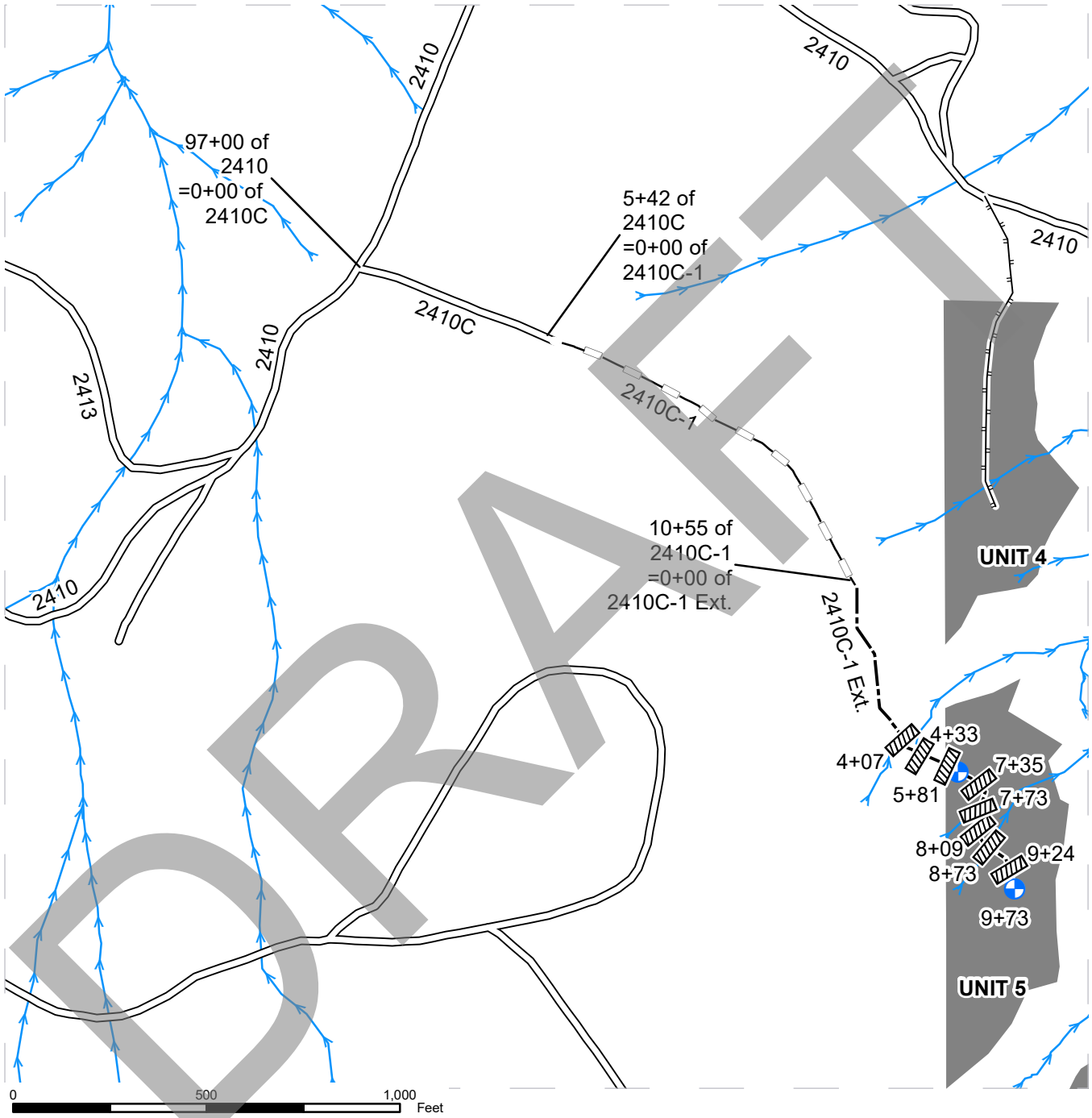

Existing Roads	Culvert	Harvest Unit
Optional Construction	Landing - Proposed	Streams
Optional Reconstruction		
Designated Skid Trail		



ROAD PLAN MAP

SALE NAME: GHOST TOWN SORTS
AGREEMENT#: 30-104392
TOWNSHIP(S): T10R2E
TRUST(S): Common School and Indemnity (3)

REGION: Pacific Cascade Region
COUNTY(S): Cowlitz
ELEVATION RGE: 1160-2160

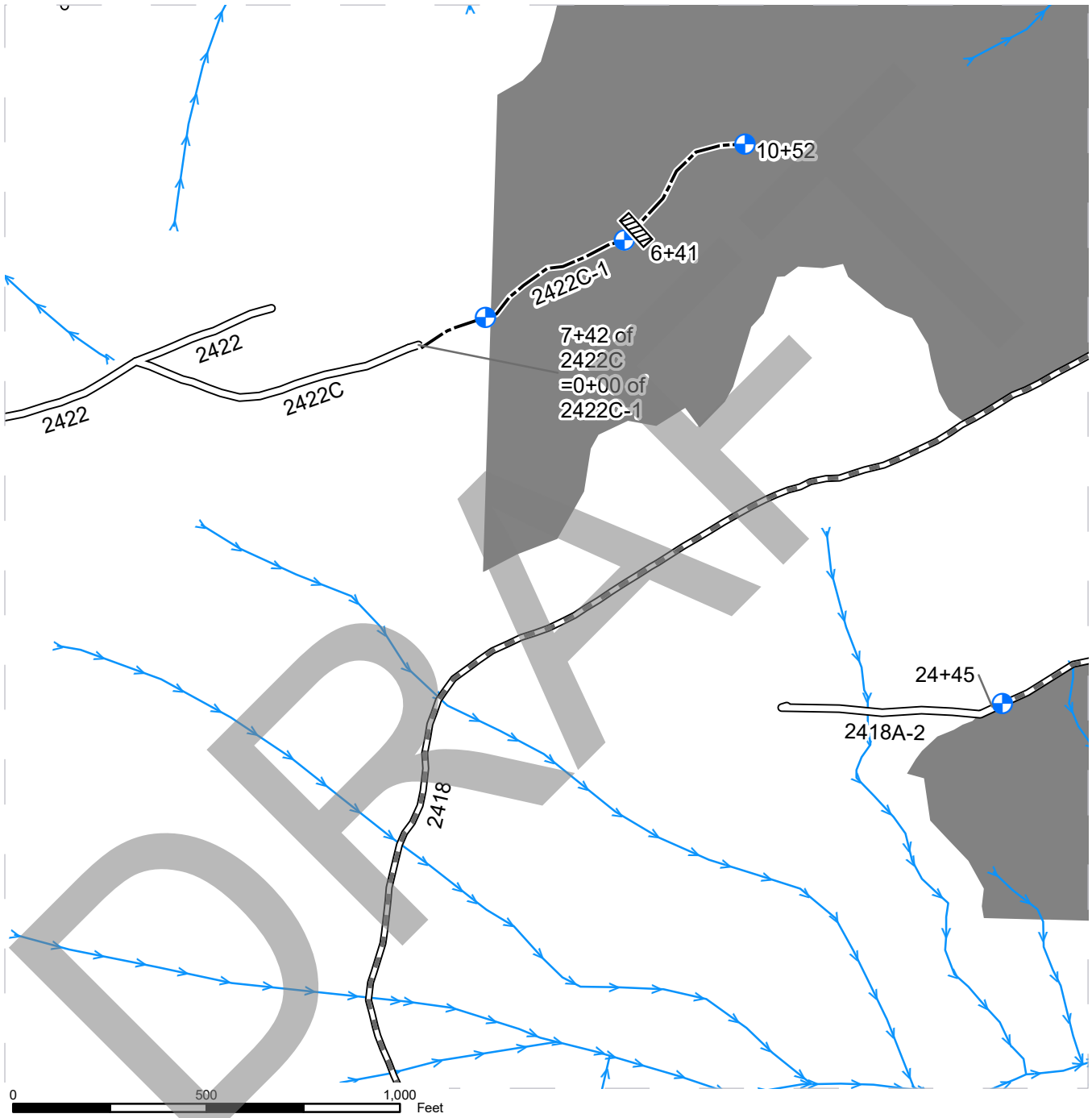

Existing Roads	Culvert	Harvest Unit
Required Pre-Haul Maintenance	Landing - Proposed	Streams
Optional Construction		



ROAD PLAN MAP

SALE NAME: GHOST TOWN SORTS
AGREEMENT#: 30-104392
TOWNSHIP(S): T10R2E
TRUST(S): Common School and Indemnity (3)

REGION: Pacific Cascade Region
COUNTY(S): Cowlitz
ELEVATION RGE: 1160-2160

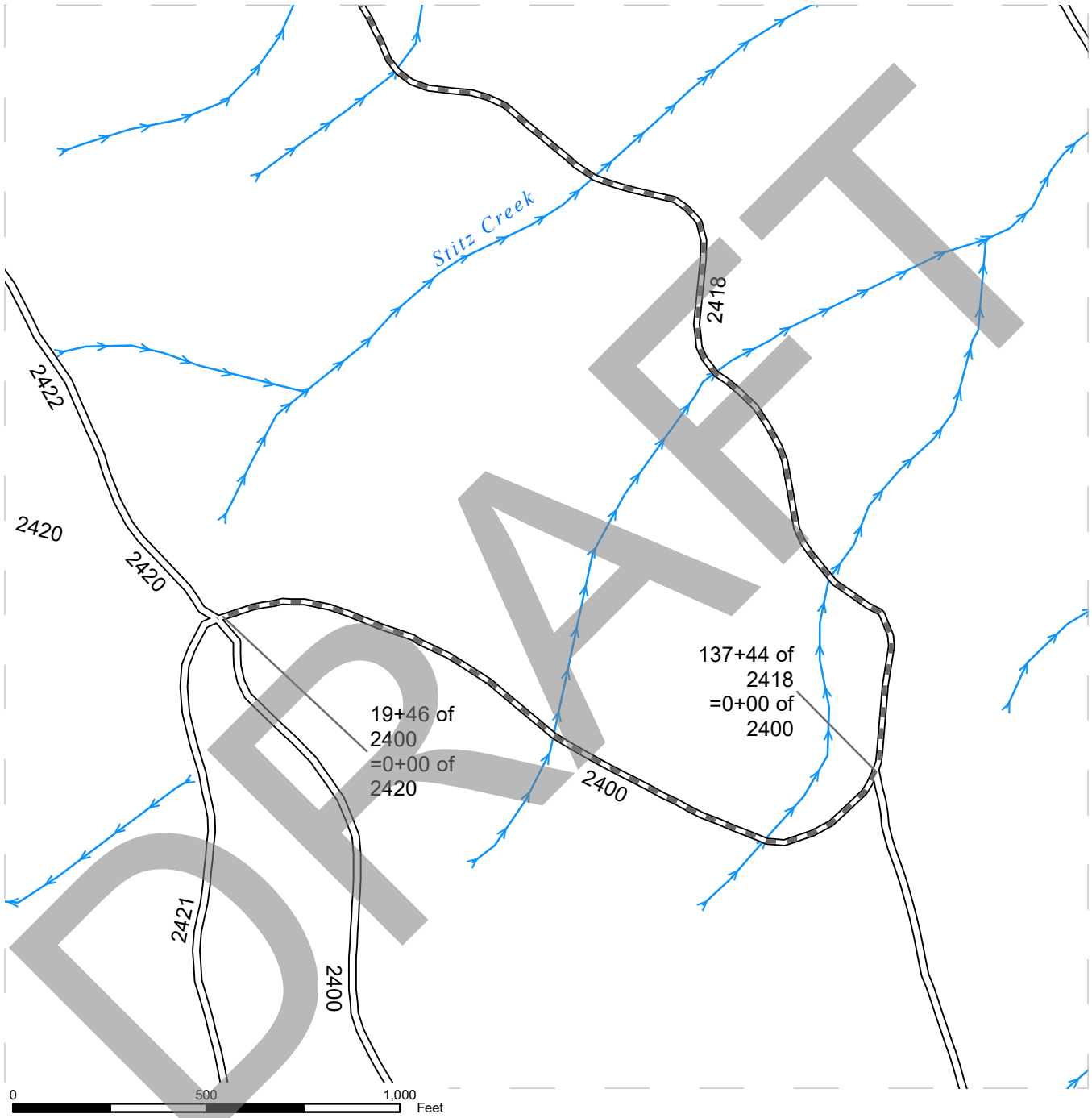

- Existing Roads
- Required Pre-Haul Maintenance
- Streams

STATE OF WASHINGTON
DEPARTMENT OF NATURAL RESOURCES

GHOST TOWN SORTS TIMBER SALE ROAD PLAN
COWLITZ COUNTY
GREEN MOUNTAIN UNIT, SAINT HELENS DISTRICT
PACIFIC CASCADE REGION

AGREEMENT NO.: 30-104392

STAFF ENGINEER: DAVID STONE

DRAWN & COMPILED BY: ALICIA COMPTON
& DAVID STONE

SECTION 0 – SCOPE OF PROJECT

0-1 ROAD PLAN SCOPE

Clauses in this road plan apply to all road related work, including landings and rock source development, unless otherwise noted.

0-2 REQUIRED ROADS

The specified work on the following roads is required.

<u>Road</u>	<u>Stations</u>	<u>Type</u>
2400	0+00 to 19+46	Pre-haul Maintenance
2411	0+00 to 24+88	Pre-haul Maintenance
2418	0+00 to 137+44	Pre-haul Maintenance
2418A-1	0+00 to 43+00	Pre-haul Maintenance
2418A-2	0+00 to 24+45	Pre-haul Maintenance
2418A-3	0+00 to 11+62	Pre-haul Maintenance
2418B	0+00 to 16+86	Pre-haul Maintenance
2418B-1	9+55 to 15+20	Abandonment

0-3 OPTIONAL ROADS

The specified work on the following roads is not required. Any optional roads built by the Contractor must meet all the specifications in the road plan.

<u>Road</u>	<u>Stations</u>	<u>Type</u>
2418A1-A	0+00 to 10+70	Reconstruction
2418B-1	0+00 to 9+55	Reconstruction
2422C-1	0+00 to 10+52	Construction
2410C-1	0+00 to 10+55	Reconstruction
2410C-1 EXT	0+00 to 9+73	Construction

0-4 CONSTRUCTION

Construction includes, but is not limited to clearing, grubbing, right-of-way debris disposal, excavation and embankment to sub-grade, landing and turnout construction, culvert installation, manufacture and application of rock, and compaction of earthwork and rock.

0-5 RECONSTRUCTION

This project includes, but is not limited to the following reconstruction requirements:

<u>Road</u>	<u>Stations</u>	<u>Requirements</u>
2418A1-A 2418B-1 2410C-1	0+00 to 10+70 0+00 to 9+55 0+00 to 10+55	Clear, grub, widen subgrade, excavate ditchlines, grade, shape, and compact subgrade surface in accordance to TYPICAL SECTION SHEET. Right-of-way debris disposal. Remove buried logs from fill at Stations 1+55 and 3+05 on 2418A1-A. Compact earthwork. Acquire and install culverts in accordance to CULVERT LIST. Reconstruct road grade according to stakes and reference points marked in the field. Apply rock in accordance to ROCK LIST. Grade, shape, and compact rock.

0-6 PRE-HAUL MAINTENANCE

This project includes, but is not limited to the following pre-haul maintenance requirements:

<u>Road</u>	<u>Stations</u>	<u>Requirements</u>
2400 2411 2418 2418B 2418A-1 2418A-2 2418A-3	0+00 to 19+46 0+00 to 24+88 0+00 to 137+44 0+00 to 16+86 0+00 to 43+00 0+00 to 24+45 0+00 to 11+62	Grade, shape, and compact existing surface in accordance to TYPICAL SECTION SHEET. Clean and widen ditchlines in accordance to TYPICAL SECTION SHEET at locations specified in Clause 2-7. Acquire and install culverts in accordance to CULVERT LIST. Apply rock in accordance to ROCK LIST. Grade, shape, and compact rock.

0-10 ABANDONMENT

This project includes abandonment listed in Clause 9-21.

0-12 DEVELOP ROCK SOURCE

Contractor may develop an existing rock source. Rock source development will involve requirements listed in the ROCK SOURCE DEVELOPMENT PLAN. Work for developing rock sources is listed in Section 6 ROCK AND SURFACING.

SECTION 1 – GENERAL

1-1 ROAD PLAN CHANGES

If the Contractor desires a change from this road plan including, but not limited to, relocation, extension, change in design, or adding roads; a revised road plan must be submitted in writing to the Contract Administrator for consideration. Before work begins, Contractor shall obtain approval from the State for the submitted plan.

1-2 NON-COMPLIANCE WITH STATE ROAD PLAN

Quantities established in this road plan are minimum acceptable values. Additional quantities required by the state due to unforeseen conditions, or Contractor's choice of construction techniques will be at the Contractor's expense.

1-3 ROAD DIMENSIONS

Contractor shall perform road work in accordance with the dimensions shown on the TYPICAL SECTION SHEET and the specifications within this road plan, unless controlled by construction stakes or design data (plan, profile, and cross-sections).

1-4 ROAD TOLERANCES

Contractor shall perform road work within the tolerances listed below. The tolerance class for each road is listed on the TYPICAL SECTION SHEET.

<u>Tolerance Class</u>	<u>A</u>	<u>B</u>	<u>C</u>
Road and Subgrade Width (feet)	+1.5	+1.5	+2.0
Subgrade Elevation (feet +/-)	0.5	1.0	2.0
Centerline alignment (feet lt./rt.)	1.0	1.5	3.0

1-6 ORDER OF PRECEDENCE

Any conflict or inconsistency in the road plan will be resolved by giving the documents precedence in the following order:

1. Addenda.
2. Designs or Plans. On designs and plans, figured dimensions shall take precedence over scaled dimensions.
3. Road Plan Clauses.
4. Typical Section Sheet.
5. Standard Lists.
6. Standard Details.
7. Road Plan Work maps.

In case of any ambiguity or dispute over interpreting the road plan, the Contract Administrator’s or designee’s decision will be final.

1-8 REPAIR OR REPLACEMENT OF DAMAGED MATERIALS

Contractor shall repair or replace all materials, roadway infrastructure, and road components damaged during road work or operation activities. The Contract Administrator will direct repairs and replacements. Repairs to structural materials must be made in accordance with the manufacturer’s recommendation, and may not begin without written approval from the Contract Administrator.

1-9 DAMAGED METALLIC COATING

Any cut ends, or damaged galvanized or aluminized coating on existing or new bridge components, culverts, downspouts, and flumes must be cleaned and treated with a minimum of two coats of zinc rich paint or cold galvanizing compound.

1-15 ROAD MARKING

Contractor shall perform road work in accordance with the state’s marked location. All road work is marked as follows:

- Four-foot stakes with orange flagging, orange paint, and/or aluminum reference tags for all road types. Right-of-Way (ROW) boundary tags – on roads with designated ROW harvest units.

1-18 REFERENCE POINT DAMAGE

Contractor shall reset reference points (RPs) that were moved or damaged at any time during construction to their original locations. Excavation and embankment may not proceed on road segments controlled by said RPs until Contractor resets all moved or damaged RPs.

1-20 COMPLETE BY DATE

Contractor shall complete road work before the start of timber haul.

1-21 HAUL APPROVAL

Contractor shall not use roads under this road plan for timber hauling, rock hauling, or right-of-way hauling, without written approval from the Contract Administrator.

1-22 WORK NOTIFICATIONS

Contractor shall notify the Contract Administrator a minimum of 5 calendar days before work begins.

1-23 ROAD WORK PHASE APPROVAL

Contractor shall obtain written approval from the Contract Administrator upon completion of each of the following phases of road work:

- Subgrade construction and drainage installation
- Waste area construction
- Subgrade compaction
- Rock pit development
- Rock application and compaction
- Abandonment

1-25 ACTIVITY TIMING RESTRICTION

The specified activities are not allowed during the listed closure periods unless authorized in writing by the Contract Administrator. Restrictions for hauling forest products are specified in Contract Clause H-130 HAULING SCHEDULE.

<u>Road</u>	<u>Activity</u>	<u>Closure Period</u>
All	Construction, Reconstruction, Pre-haul Maintenance, Rock Source Work, & Abandonment	October 1 to April 30

1-26 OPERATING DURING CLOSURE PERIOD

If permission is granted to operate during a closure period listed in Clause 1-25 ACTIVITY TIMING RESTRICTION, Contractor shall provide a maintenance plan to include further protection of state resources. Contractor shall obtain written approval from the Contract Administrator for the maintenance plan, and shall put preventative measures in place before operating during the closure period. Contractor is required to maintain all haul roads at their own expense including those listed in Contract Clause C-60.1 DESIGNATED ROAD MAINTAINER. If other operators are using, or desire to use these designated maintainer roads, a joint operating plan must be developed. All parties shall follow this plan.

1-29 SEDIMENT RESTRICTION

Contractor shall not allow silt-bearing runoff to enter any streams.

1-30 CLOSURE TO PREVENT DAMAGE

In accordance with Contract Clause G-220 STATE SUSPENDS OPERATION, the Contract Administrator will suspend road work or hauling right-of-way timber, forest products, or rock under the following conditions:

- Wheel track rutting exceeds 4 inches on jaw run roads.
- Wheel track rutting exceeds 2 inches on crushed rock roads.
- Wheel track rutting exceeds 2 inches on native surface roads.
- Surface or base stability problems persist.
- Weather is such that satisfactory results cannot be obtained in an area of operations.
- When, in the opinion of the Contract Administrator excessive road damage or rutting may occur.

Operations must stop unless authority to continue working or hauling is granted in writing by the Contract Administrator. In the event that surface or base stability problems persist, Contractor shall cease operations, or perform corrective maintenance or repairs, subject to specifications within this road plan.

1-32 BRIDGE AND ASPHALT SURFACE RESTRICTION

The use of metal tracked equipment is not allowed on bridge or asphalt surfaces at any time. If Contractor must run equipment on bridge or asphalt surfaces, then rubber tired equipment or other methods, approved in writing by Contract Administrator, must be used. Other methods must meet the following criteria: Material utilized to protect the deck surface from tracked equipment damage must be of substantial thickness, durability and width to support the machine weight and prevent grousers from touching the bridge deck and asphalt surfaces. The only exception when metal tracked equipment on bridges is allowed, is when a bridge has a designed crushed rock surface for the decking.

If tracked equipment is used on bridge or asphalt surfaces, Contractor shall immediately cease all road construction and hauling operations. Contractor shall remove any dirt, rock, or other material tracked or spilled on the bridge or asphalt surfaces and have surfaces evaluated by the District Engineer or their designee for any damage caused by transporting equipment. Any damage to the surfaces will be repaired, at the Contractor's expense, as directed by the Contract Administrator.

1-33 SNOW PLOWING RESTRICTION

Snowplowing will be allowed after the execution of a SNOW PLOWING AGREEMENT, which is available from the Contract Administrator upon request. Contractor shall request a SNOW PLOWING AGREEMENT each time plowing occurs. If damage occurs while plowing, further permission to plow may be revoked by the Contract Administrator.

1-40 ROAD APPROACHES TO COUNTY ROADS AND STATE HIGHWAYS

Contractor shall immediately remove any mud, dirt, rock, or other material tracked or spilled on to county roads and state highways.

If additional damage to the surface, signs, guardrails, etc. occurs then the damage will be repaired, at the Contractor's expense, as directed by the Contract Administrator when authorized by the county or WSDOT.

SECTION 2 – MAINTENANCE

2-1 GENERAL ROAD MAINTENANCE

Contractor shall maintain all roads used under this contract in accordance with the FOREST ACCESS ROAD MAINTENANCE SPECIFICATIONS for the entire term of this contract. Maintenance is required even during periods of inactivity.

2-2 ROAD MAINTENANCE – CONTRACTOR MAINTENANCE

Contractor shall perform maintenance on roads listed in Contract Clause C-050.1 CONTRACTOR ROAD MAINTENANCE AND REPAIR in accordance with FOREST ACCESS ROAD MAINTENANCE SPECIFICATIONS.

2-3 ROAD MAINTENANCE – DESIGNATED MAINTAINER

Contractor may be required to perform maintenance on roads listed in Contract Clause C-060.1 DESIGNATED ROAD MAINTAINER as directed by the Contract Administrator. Contractor shall maintain roads in accordance with FOREST ACCESS ROAD MAINTENANCE SPECIFICATIONS.

2-4 PASSAGE OF LIGHT VEHICLES

Contractor shall maintain roads in a condition that will allow the passage of light administrative vehicles.

2-5 MAINTENANCE GRADING – EXISTING ROAD

Contractor shall use a grader to shape the existing surface before applying rock.

2-7 CLEANING DITCHES, HEADWALLS, AND CATCH BASINS

On the following roads, Contractor shall clean ditches, headwalls, and catch basins. Pulling ditch material across the road or mixing in with the road surface is not allowed. Scatter material down slope outside of cleared right-of-way.

<u>Road</u>	<u>Stations</u>
2400	0+00 to 19+46
2411	0+00 to 24+88
2418	0+00 to 137+44
2418A-1	0+00 to 43+00
2418A-2	0+00 to 24+45
2418A-3	0+00 to 11+62
2418B	0+00 to 16+86

SECTION 3 – CLEARING, GRUBBING, AND DISPOSAL

3-5 CLEARING

Contractor shall fall all vegetative material larger than 2 inches DBH or over 5 feet high between the marked right-of-way boundaries and within waste and debris areas, or if not marked in the field, between the clearing limits specified on the TYPICAL SECTION SHEET. Clearing must be completed before starting excavation and embankment.

3-7 RIGHT-OF-WAY DECKING

Contractor shall deck all right-of-way timber. Decks must be parallel to the road centerline and placed within the cleared right-of-way. Decks must be free of dirt, limbs, and other right-of-way debris, and removable by standard log loading equipment from the roadbed.

3-8 PROHIBITED DECKING AREAS

Contractor shall not deck right-of-way timber in the following areas:

- Within the grubbing limits.
- Within 50 feet of any stream.
- In locations that interfere with the construction of the road prism.
- In locations that impede drainage.
- On slopes greater than 45%.
- Against standing trees.
- On slopes above a cut bank.

3-10 GRUBBING

Contractor shall remove all stumps between the grubbing limits specified on the TYPICAL SECTION SHEET. Contractor shall also remove stumps with undercut roots outside the grubbing limits. Stumps over 22 inches diameter must be split. Stumps over 40 inches must be quartered. Grubbing must be completed before starting excavation and embankment.

3-12 STUMP PLACEMENT

Contractor shall place grubbed stumps outside of the clearing limits as directed by the Contract Administrator and in compliance with all other clauses in this road plan. Stumps must be positioned upright, with root wads in contact with the forest floor on stable locations

3-14 STUMPS WITHIN DESIGNATED WASTE AREAS

Contractor is not required to remove stumps within waste areas if they are cut flush with the ground.

3-20 ORGANIC DEBRIS DEFINITION

Organic debris is defined as all vegetative material not eligible for removal by Contract Clause G-010 PRODUCTS SOLD AND SALE AREA or G-011 RIGHT TO REMOVE FOREST PRODUCTS AND CONTRACT AREA, that is larger than one cubic foot in volume within the clearing and waste area limits.

3-21 DISPOSAL COMPLETION

Contractor shall remove organic debris from the road surface, ditchlines, and culvert inlets and outlets. Contractor shall complete all disposal of organic debris, before subgrade approval.

3-22 DESIGNATED WASTE AREA FOR ORGANIC DEBRIS

Waste areas for organic debris are located as listed below and at areas approved in writing by the Contract Administrator.

<u>Road</u>	<u>Disposal Location</u>
Signal Pit	On the left side of the 4253F at station 3+70
2418B-1 Abandonment	On the right side of the 2418B-1 at station 13+35

3-23 PROHIBITED DISPOSAL AREAS

Contractor shall not place organic debris in the following areas:

- Within 50 feet of a cross drain culvert.
- Within 100 feet of a live stream, or wetland.
- On road subgrades, or excavation and embankment slopes.
- On slopes greater than 45%.
- Within the operational area for cable landings where debris may shift or roll.
- On locations where brush can fall into the ditch or onto the road surface.
- Against standing timber.
- On slopes above a cut bank.

3-24 BURYING ORGANIC DEBRIS RESTRICTED

Contractor shall not bury organic debris unless otherwise stated in this plan.

3-25 SCATTERING ORGANIC DEBRIS

Contractor shall scatter organic debris outside of the clearing limits in natural openings downhill side of the road, unless otherwise detailed in this road plan and as directed by the Contract Administrator.

3-32 END HAULING ORGANIC DEBRIS

On the following roads and on slopes greater than 45%, Contractor shall end haul or push organic debris to the designated waste areas specified in Clause 3-22 DESIGNATED WASTE AREA FOR ORGANIC DEBRIS, or to a waste area located by the Contract Administrator.

<u>Road</u>	<u>Stations</u>
2418B-1	12+35 to 12+85
Abandonment	13+75 to 14+90
Signal Pit	Mining Location on Pit Development Plan Map

SECTION 4 – EXCAVATION

4-2 PIONEERING

Pioneering may not extend past construction that will be completed during the current construction season. Pioneering may not extend more than 1000 feet beyond completed construction unless approved in writing by the Contract Administrator. In addition, the following actions must be taken as pioneering progresses:

- Drainage must be provided on all uncompleted construction.
- Road pioneering operations may not undercut the final cut slope or restrict drainage.
- Culverts at live stream crossings must be installed during pioneering operations prior to embankment.

4-3 ROAD GRADE AND ALIGNMENT STANDARDS

Contractor shall follow these standards for road grade and alignment:

- Grade and alignment must have smooth continuity, without abrupt changes in direction.
- Maximum grades may not exceed 18 percent favorable and 13 percent adverse.
- Minimum curve radius is 60 feet at centerline.
- Maximum grade change for sag vertical curves is 6% in 100 feet.
- Maximum grade change for crest vertical curves is 4% in 100 feet.

4-4 SWITCHBACK STANDARDS

A switchback is defined as a curved segment of road between a beginning and end of the same curve, where the change of traffic travel direction is greater than 90 degrees. Contractor shall follow these standards for switchbacks:

- Maximum adverse grades for switchbacks is 10% of the curve radius.
- Maximum favorable grades for switchbacks is 12%.
- Maximum transition grades entering and leaving switchbacks is a 5% grade change.
- Transition grades required to meet switchback grade limitations must be constructed on the tangents preceding and departing from the switchbacks.

4-5 CUT SLOPE RATIO

Contractor shall construct excavation slopes no steeper than shown on the following table, unless construction staked or designed:

<u>Material Type</u>	<u>Excavation Slope Ratio</u>	<u>Excavation Slope Percent</u>
Common Earth (on side slopes up to 55%)	1:1	100
Common Earth (56% to 70% side slopes)	¾:1	133
Common Earth (on slopes over 70%)	½:1	200
Fractured or loose rock	½:1	200
Hardpan or solid rock	¼:1	400

4-6 EMBANKMENT SLOPE RATIO

Contractor shall construct embankment slopes no steeper than shown on the following table:

<u>Material Type</u>	<u>Embankment Slope Ratio</u>	<u>Embankment Slope Percent</u>
Sandy Soils	2:1	50
Common Earth and Rounded Gravel	1½:1	67
Angular Rock	1¼:1	80

4-7 SHAPING CUT AND FILL SLOPE

Contractor shall construct excavation and embankment slopes to a uniform line and left rough for easier revegetation.

4-8 CURVE WIDENING

The minimum widening placed on the inside of curves is:

- 6 feet for curves of 50 to 79 feet radius.
- 4 feet for curves of 80 to 100 feet radius.

4-9 EMBANKMENT WIDENING

The minimum embankment widening is:

- 2 feet for embankment heights at centerline of 3 to 6 feet.
- 4 feet for embankment heights at centerline of greater than 6 feet.

Contractor shall apply embankment widening equally to both sides of the road to achieve the required width.

4-10 WIDEN THE EXISTING SUBGRADE

On the following roads, Contractor shall widen the subgrade and fill slopes to the dimensions shown on the TYPICAL SECTION SHEET. If necessary, Contractor shall reconstruct excavation slopes to provide sufficient width for the road surface and any ditches.

<u>Road</u>	<u>Stations</u>
2418A1-A	0+00 to 10+70
2418B-1	0+00 to 9+55
2410C-1	0+00 to 10+55

4-21 TURNOUTS

Contractor shall construct non designated turnouts intervisible with a maximum distance of 1000 feet between turnouts. Locations may be adjusted to fit the final subgrade alignment and sight distances. Locations changes are subject to written approval by the Contract Administrator. Minimum dimensions are shown on the TYPICAL SECTION SHEET and ROCK LIST.

4-22 TURNAROUNDS

Turnarounds must be no larger than 30 feet long and 30 feet wide. Locations are subject to written approval by the Contract Administrator.

4-25 DITCH CONSTRUCTION AND RECONSTRUCTION

Contractor shall construct reconstruct ditches into the subgrade as specified on the TYPICAL SECTION SHEET. Ditches must be constructed concurrently with construction of the subgrade.

4-28 DITCH DRAINAGE

Ditches must drain to cross-drain culverts or ditchouts.

4-29 DITCHOUTS

Contractor shall construct ditchouts as identified on the CULVERT LIST and as directed by the Contract Administrator. Ditchouts must be constructed in a manner that diverts ditch water onto the forest floor and must have excavation backslopes no steeper than a 1:1 ratio.

4-35 WASTE MATERIAL DEFINITION

Waste material is defined as all dirt, rock, mud, or related material that is extraneous or unsuitable for construction material. Waste material, as used in Section 4 EXCAVATION, is not organic debris.

4-36 DISPOSAL OF WASTE MATERIAL

Contractor may sidecast waste material on side slopes up to 45% if the waste material is compacted and free of organic debris. On side slopes greater than 45%, all waste material must be end hauled or pushed to the designated embankment sites and waste areas identified in Clause 4-37 WASTE AREA LOCATION.

4-37 WASTE AREA LOCATION

Contractor shall deposit waste material in the listed designated areas. Additional waste areas may also be identified or approved by the Contract Administrator. The amount of material allowed in a waste area is at the discretion of the Contract Administrator.

<u>Road</u>	<u>Waste Area Location</u>	<u>Comments</u>
Signal Pit	On the left side of the 4253F at station 3+70	Pile Organic material separately from all other waste
2418B-1 Abandonment	On the right side of the 2418B-1 at station 13+35	

4-38 PROHIBITED WASTE DISPOSAL AREAS

Contractor shall not deposit waste material in the following areas, except as otherwise specified in this plan:

- Within 25 feet of a cross drain culvert.
- Within 100 feet of a live stream or wetland.
- Within a riparian management zone.
- Within a wetland management zone.
- On side slopes steeper than 45%.
- In locations that interfere with the construction of the road prism.
- In locations that impede drainage.
- Within the operational area for cable landings.
- Against standing timber.

4-48 NATIVE MATERIAL

Native material consists of naturally occurring material that is free of organic debris, trash, and rocks greater than 4 inches in any dimension.

4-55 ROAD SHAPING

Contractor shall shape the subgrade and surface as shown on the TYPICAL SECTION SHEET. The subgrade and surface shape must ensure runoff in an even, un-concentrated manner, and must be uniform, firm, and rut-free.

4-56 DRY WEATHER SHAPING

The Contract Administrator may require the application of water to facilitate shaping activities. The method of water application is subject to written approval by the Contract Administrator.

4-60 FILL COMPACTION

Contractor shall compact all embankment and waste material in accordance with the COMPACTION LIST by routing equipment over the entire width of each lift. A plate compactor must be used for areas specifically requiring keyed embankment construction and for embankment, waste area, and segments too narrow to accommodate equipment.

4-61 SUBGRADE COMPACTION

Contractor shall compact constructed and reconstructed subgrades in accordance with the COMPACTION LIST by routing equipment over the entire width except ditch. Contractor shall obtain written approval from the Contract Administrator for subgrade compaction before rock application and timber haul.

4-62 DRY WEATHER COMPACTION

The Contract Administrator may require the application of water to facilitate compaction activities. The method of water application is subject to written approval by the Contract Administrator.

4-63 EXISTING SURFACE COMPACTION

Contractor shall compact maintained road surfaces in accordance with the COMPACTION LIST by routing equipment over the entire width.

SECTION 5 – DRAINAGE

5-5 CULVERTS

Contractor shall install culverts as part of this contract. Culverts must be installed concurrently with subgrade work and must be installed before subgrade compaction and rock application. Culvert locations and the minimum requirements for culvert length and diameter are designated on the CULVERT LIST. Culvert, downspout, and flume lengths may be adjusted to fit as-built conditions and may not terminate directly on unprotected soil. Culverts must be new material and meet the specifications in Clauses 10-15 through 10-24.

5-6 CULVERT TYPE

Contractor shall install culverts made of steel or plastic in accordance with Clauses 10-15 through 10-24.

5-10 CULVERT MARKER INSTALLATION

Contractor shall provide and install culvert markers at the inlet in accordance with the CULVERT AND DRAINAGE SPECIFICATION DETAIL and CULVERT LIST.

5-12 UNUSED MATERIALS STATE PROPERTY

On required roads, any materials listed on the CULVERT LIST that are not installed will become the property of the state. Contractor shall stockpile materials as directed by the Contract Administrator.

5-15 CULVERT INSTALLATION

Culvert installation must be in accordance with the CULVERT AND DRAINAGE SPECIFICATION DETAIL, LIVE STREAM INSTALLATION PROCEDURE DETAIL, the National Corrugated Metal Pipe Association's "Installation Manual for Corrugated Steel Drainage Structures", and the Corrugated Polyethylene Pipe Association's "Recommended Installation Practices for Corrugated Polyethylene Pipe and Fittings". Corrugated Polyethylene pipe must be installed in a manner consistent with the manufacturer's recommendations.

5-17 CROSS DRAIN SKEW AND SLOPE

Cross drains, on road grades in excess of 3%, must be skewed at least 30 degrees from perpendicular to the road centerline, except where the cross drain is at the low point in the road culverts will not be skewed. Cross drain culverts must be installed at a slope steeper than the incoming ditch grade, but not less than 3% or more than 10%.

5-18 CULVERT DEPTH OF COVER

All culverts must be installed with a depth of cover of not less than 1 foot of compacted subgrade over the top of the culvert at the shallowest point, and as recommended by the culvert manufacturer for the type and size of the pipe.

5-20 ENERGY DISSIPATERS

Contractor shall install energy dissipaters in accordance with the CULVERT AND DRAINAGE SPECIFICATION DETAIL at all culverts on the CULVERT LIST that specify the placement of rock. Energy dissipater installation is subject to approval by the Contract Administrator. The type of energy dissipater and the amount of material must be consistent with the specifications listed on the CULVERT LIST. Placement must with a zero-drop-height only. No placement by end dumping or dropping of rock is allowed.

5-25 CATCH BASINS

Contractor shall construct catch basins in accordance with CULVERT AND DRAINAGE SPECIFICATION DETAIL. Minimum dimensions of catch basins are 3 feet wide and 4 feet long with back slopes consistent with Clause 4-5 CUT SLOPE RATIO.

5-26 HEADWALLS FOR CROSS DRAIN CULVERTS

Contractor shall construct headwalls in accordance with the CULVERT AND DRAINAGE SPECIFICATION DETAIL and CULVERT LIST at all cross drain culverts. Rock must be placed on shoulders, slopes, and around culvert inlets and outlets. Minimum specifications require that rock be placed at a width of one culvert diameter on each side of the culvert opening, and to a height of one culvert diameter above the top of the culvert. Rock may not restrict the flow of water into culvert inlets or catch basins. Rock must be set in place by machine. Placement must be with a zero-drop-height only. No placement by end dumping or dropping of rock is allowed. Rock type must meet the specifications in Clause 6-50 LIGHT LOOSE RIP RAP.

5-27 ARMORING FOR STREAM CROSSING CULVERTS

At the following culverts, Contractor shall place rock in conjunction with construction of the embankment. Rock must be placed on shoulders, slopes, and around culvert inlets and outlets as designated on the CULVERT LIST and as directed by the Contract Administrator. Rock may not restrict the flow of water into culvert inlets or catch basins. Rock must be set in place by machine. Placement must be with a zero-drop-height only. No placement by end dumping or dropping of rock is allowed. Rock type must meet the specifications in Clause 6-50 LIGHT LOOSE RIP RAP.

<u>Road</u>	<u>Stations</u>	<u>Rock Type</u>
2418A1-A	1+55 & 3+05	LIGHT LOOSE RIP RAP
2410C-1 EXT	4+07, 7+73, & 8+73	LIGHT LOOSE RIP RAP

5-33 NATIVE SURFACE ROADS

If overwintered, native surface roads must be waterbarred by October 1. Contractor shall construct waterbars according to the attached NON-DRIVABLE WATERBAR DETAIL at a maximum spacing that will produce a vertical distance of no more than 10 feet between waterbars or between natural drainage paths, and with a maximum spacing of 200 feet.

SECTION 6 – ROCK AND SURFACING

6-2 ROCK SOURCE ON STATE LAND

Rock used in accordance with the quantities on the ROCK LIST may be obtained from the following source on state land at no charge to the Contractor. Contractor shall obtain written approval from the Contract Administrator for the use of material from any other source. If other operators are using, or desire to use the rock source, a joint operating plan must be developed. All parties shall follow this plan. Contractor shall notify the Contract Administrator a minimum of 5 business days before starting any operations in the listed locations.

<u>Source</u>	<u>Location</u>
Signal Pit	SW1/4 Sec. 03, T09N, R02E, W.M.

6-5 ROCK FROM COMMERCIAL SOURCE

Rock used in accordance with the quantities on the ROCK LIST may be obtained from any commercial source at the Contractor's expense. Rock sources are subject to written approval by the Contract Administrator before their use. Rock source must be a WSDOT certified source.

6-10 ROCK SOURCE DEVELOPMENT PLAN BY STATE

Contractor shall conduct rock source development and use at the following sources, in accordance with the written ROCK SOURCE DEVELOPMENT PLAN prepared by the state and included in this road plan. Upon completion of operations, the rock source must be left in the condition specified in the ROCK SOURCE DEVELOPMENT PLAN, and approved in writing by the Contract Administrator. Contractor shall notify the Contract Administrator a minimum of 5 business days before starting any operations in the rock source.

<u>Source</u>	<u>Location</u>
Signal Pit	SW1/4 Sec. 03, T09N, R02E, W.M.

6-22 FRACTURE REQUIREMENT FOR ROCK

A minimum of 50% by visual inspection of coarse aggregate must have at least one fractured face. Coarse aggregate is the material greater than 1/4-inch in size.

6-23 ROCK GRADATION TYPES

Contractor shall provide or manufacture rock in accordance with the types and amounts listed in the ROCK LIST. Rock must meet the following specifications for gradation and uniform quality during manufacture and placement into a stockpile. The exact point of evaluation for conformance to specifications will be determined by the Contract Administrator. Contractor shall provide a sieve analysis upon request from the Contract Administrator. Gradation specifications in Clauses 6-28, 6-34 and 6-50.

6-28 1 ¼-INCH MINUS CRUSHED ROCK

% Passing 1 ¼" square sieve	100%
% Passing 5/8" square sieve	55 - 75%
% Passing U.S. #4 sieve	20 - 50%

Of the fraction passing the No. 4 sieve, 40% to 60% must pass the No. 10 sieve.

The portion of aggregate retained on the No. 4 sieve may not contain more than 0.2 percent organic debris and trash. All percentages are by weight.

6-34 3-INCH JAW RUN ROCK

% Passing 3" square sieve	100%
% Passing 1 ½" square sieve	45 - 65%

Ballast rock must be 100% equal to, or smaller than, 3 inches in at least one dimension. Rock may contain no more than 5 percent organic debris, and trash. All percentages are by weight.

6-50 LIGHT LOOSE RIP RAP

Light loose rip rap must consist of angular, hard, sound, and durable stone. It must be free from segregation, seams, cracks, and other defects tending to destroy its resistance to weather. Light loose rip rap must be free of rock fines, soil, organic debris or other extraneous material, and must meet the following requirements:

<u>Quantity</u>	<u>Approximate Size Range</u>
20% to 90%	18" - 28"
15% to 80%	8" - 18"
10% to 20%	3" - 8"

6-55 ROCK APPLICATION MEASURED BY COMPACTED DEPTH

Measurement of specified rock depths, are defined as the compacted depths using the compaction methods required in this road plan. Estimated quantities specified in the ROCK LIST are loose yards. Contractor shall apply adequate amounts of rock to meet the specified rock depths. Specified rock depths are minimum requirements and are not subject to reduction. Unless otherwise stated in Clause 6-75 OPTIONAL ROCK EXCEPTION.

6-56 ROCK MEASUREMENT BY TRUCK VOLUME

Measurement of Spot Rocking, Landing, Junction, Stockpile, and Rip Rap Rock is on a cubic yard truck measure basis. The Contract Administrator will measure each truck box before rock hauling. An average of such volumes for each truck will be used to tally the volume hauled. The Contract Administrator may periodically require that a load be flattened off and its volume calculated. Contractor shall maintain load tally sheets for each truck as shown in ROCK ACCOUNTABILITY DETAIL and shall give them to the Contract Administrator or mail them to the Pacific Cascade Region Office on a weekly basis during rocking operations.

6-65 ROCK STOCKPILE LOCATION

Contractor shall stockpile rock as listed below. Rock stockpiles must be in accordance Clause 6-67 ROCK STOCKPILE SPECIFICATIONS.

<u>Rock Source</u>	<u>Rock Type</u>	<u>Quantity (c.y.)</u>	<u>Stockpile Location</u>
Signal Pit	1 ¼ Inch Minus	1,000	On the Right side of the 4253F at station 2+30

6-67 ROCK STOCKPILE SPECIFICATIONS

Rock stockpiles listed in Clause 6-65 ROCK STOCKPILE LOCATION must meet the following specifications:

Before placing aggregates upon the stockpile site, the site must be cleared of vegetation, trees, stumps, brush, rocks, or other debris and the ground leveled to a smooth, firm, uniform surface sloped at 2 percent and ditched as required.

When completed, the stockpile must be neat and regular in shape. The stockpile height is limited to a maximum of 15 feet. Stockpiles in excess of 200 cubic yards must be built up in layers of not more than 5 feet deep. Stockpile layers must be constructed by trucks, clamshells, or other methods approved in writing by the Contract Administrator. Each layer must be completed over the entire area of the pile before depositing aggregates in the next layer. The aggregates may not be dumped so that they run down and over the lower layers in the stockpile. Pushing aggregates into piles with a bulldozer shall not be permitted. The method of dropping from a bucket or spout in one location to form a cone shaped pile is not allowed.

Stockpiles of different types or sizes of aggregate must be spaced far enough apart, or separated by suitable walls or partitions, to prevent the mixing of the aggregates.

6-70 APPROVAL BEFORE ROCK APPLICATION

Contractor shall obtain written approval from the Contract Administrator for completed subgrade and drainage installation, including inlet and outlet armor, before rock application.

6-71 ROCK APPLICATION

Contractor shall apply rock in accordance with the specifications and quantities shown on the ROCK LIST. Rock must be spread, shaped, and compacted full width concurrent with rock hauling operations. Road surfaces must be compacted in accordance with the COMPACTION LIST by routing equipment over the entire width.

6-73 ROCK FOR WIDENED PORTIONS

Contractor shall apply rock to turnarounds, turnouts, and areas with curve widening to the same depth and specifications as the traveled way.

6-75 OPTIONAL ROCK EXCEPTION

On the following roads, if hauling takes place from June 1 to September 30 Contractor may provide and place less rock than shown on the ROCK LIST, when approved in writing by the Contract Administrator.

If less rock is applied, Contractor shall submit a written plan, for approval, describing how these roads will be constructed, used, maintained, and treated post-haul. Contractor shall meet post-haul specifications in Section 9 POST-HAUL ROAD WORK, the FOREST ACCESS ROAD MAINTENANCE SPECIFICATIONS, or other conditions of the approved plan.

<u>Road</u>	<u>Stations</u>
2422C-1	0+00 to 10+52

6-76 DRY WEATHER ROCK COMPACTION

The Contract Administrator may require the application of water to facilitate compaction of the rock surfacing. The method of water application is subject to approval by the Contract Administrator.

SECTION 8 – EROSION CONTROL

8-1 SEDIMENT CONTROL STRUCTURES

On the following roads, Contractor shall install sediment traps in ditchlines in accordance with the SEDIMENT TRAP DETAIL. On all roads, Sediment control in ditchlines shall be accomplished by using SEDIMENT TRAPS or other methods, as directed by the Contract Administrator.

<u>Road</u>	<u>Stations</u>
2418A1	11+50
2418A1-A	2+95

8-2 PROTECTION FOR EXPOSED SOIL

Contractor shall provide and evenly spread a 4-inch layer of straw to all exposed soils within 100 feet of a stream or wetland. Soils must be covered before the first anticipated storm event. Soils may not sit exposed during any rain event.

8-15 REVEGETATION

Contractor shall spread grass seed on all exposed soils within the grubbing limits resulting from road work activities using. Other methods of covering must be approved in writing by the Contract Administrator.

<u>Road</u>	<u>Location</u>	<u>Qty (lbs)*</u>	<u>Abandonment</u>
2400	0+00 to 19+46 , Ditchline	2.9	
2411	0+00 to 24+88, Ditchline	3.6	
2418	0+00 to 137+44, Ditchline & Landings	22.0	
2418A-1	0+00 to 43+00, Ditchline & Landings	13.0	
2418A-2	0+00 to 24+45, Ditchline & Landings	8.9	
2418A-3	0+00 to 11+62, Ditchline & Landings	7.1	
2418B	0+00 to 16+86, Ditchline & Landings	5.4	
2418A1-A	0+00 to 10+70	16.6	
2418B-1	0+00 to 9+55	15.0	
2418B-1	9+55 to 15+20, Abandonment only		23.2
2422C-1	0+00 to 10+52	21.9	
2410C-1	0+00 to 10+55	14.4	
2410C-1 EXT	0+00 to 9+73	19.8	
Signal Pit	Pit/Access Road/Waste Area	7.9	

*Quantities are estimates only. Actual quantities may vary and are the responsibility of the Contractor.

8-16 REVEGETATION SUPPLY

The Contractor shall provide the grass seed.

8-17 REVEGETATION TIMING

Contractor shall revegetate during the first available opportunity after road work is completed. Soils may not be allowed to sit exposed for longer than one month without receiving revegetation treatment unless otherwise approved in writing by the Contract Administrator.

8-19 ASSURANCE FOR SEEDED AREA

Contractor shall ensure the growth of a uniform and dense crop at least 75% coverage of 3-inch tall grass. Contractor shall reapply the grass seed in areas that have failed to germinate or have been damaged through any cause, restore eroded or disturbed areas, clean up and properly dispose of eroded materials, and reapply the grass seed at no additional cost to the state.

8-25 GRASS SEED

Contractor shall evenly spread the seed mixture listed below on all exposed soil inside the grubbing limits at a rate of 40 pounds per acre of exposed soil. Grass seed must meet the following specifications:

1. Weed seed may not exceed 0.5% by weight.
2. All seed species must have a minimum 90% germination rate, unless otherwise specified.
3. Seed must be certified.
4. Seed must be furnished in standard containers showing the following information:
 - a. Common name of seed
 - b. Net weight
 - c. Percent of purity
 - d. Percentage of germination
 - e. Percentage of weed seed and inert material
5. Seed must conform to the following mixture unless a comparable mix is approved in writing by the Contract Administrator.

<u>Kind and Variety of Seed in Mixture</u>	<u>% by Weight</u>	<u>Minimum % germination</u>
Perennial Rye	25-35	90
Red Fescue	40-50	90
Highland Bent	5-15	85
Red and White Clover	10-20	90
Inert and Other Crop	0.5	

SECTION 9 – POST-HAUL ROAD WORK

9-1 EARTHEN BARRICADES

On the following roads, barricades shall be constructed in accordance with the EARTHEN BARRICADE DETAIL.

<u>Road</u>	<u>Stations</u>
2418A-2	24+45
2418B-1	9+55

9-2 CULVERT REMOVAL FROM LIVE STREAM

On the following road, Contractor shall remove existing culverts from live streams and leave the resulting channel open with excavation slope and excavated channel width as specified. End haul excavated material to a waste area designated in Clause 4-37 WASTE AREA LOCATION. Culvert removal from live streams must be in accordance with the LIVE STREAM CULVERT REMOVAL PROCEDURE DETAIL, FILL REMOVAL DETAIL, TYPICAL ABANDONMENT/DEACTIVATED STREAM CROSSING DETAIL, and SETTLING POND AND PUMP DETAIL.

<u>Road</u>	<u>Stations</u>	<u>Excavated Channel Width</u>	<u>Slope Ratio</u>	<u>Comments</u>
2418B-1	12+60	4.3 feet	1 ½:1	Remove fill to native channel depth
2418B-1	14+50	1.9 feet	1 ½:1	Remove fill to native channel depth

9-3 CULVERT MATERIAL REMOVED FROM STATE LAND

Culverts removed from roads become the property of the Contractor and must be removed from state land.

9-5 POST-HAUL MAINTENANCE

Contractor shall perform post-haul maintenance in accordance with the FOREST ACCESS ROAD MAINTENANCE SPECIFICATIONS.

9-10 LANDING DRAINAGE

Contractor shall provide for drainage of the landing surface.

9-11 LANDING EMBANKMENT

Contractor shall slope landing embankments to the original construction specifications.

9-12 LANDING EMBANKMENT REMOVAL

Contractor shall reduce or relocate the landing embankment, as directed by the Contract Administrator. Place excavated material in a waste area designated by the Contract Administrator.

9-21 ROAD ABANDONMENT

Contractor shall abandon the following roads by the specified date. Work must be in accordance with the ROAD ABANDONMENT CROSS SECTIONS DETAIL and Clause 9-24 HEAVY ABANDONMENT.

<u>Road</u>	<u>Stations</u>	<u>Type</u>	<u>Date</u>
2418B-1	9+55 to 15+20	Heavy	Before October 31, 2024

9-24 HEAVY ABANDONMENT

- Fill in ditches.
- Outslope the surface to conform to natural ground.
- Remove embankments, sidecast fill, and place material into cut-banks and shape banks to conform to the natural ground. End haul surplus excavation material to waste area at Station 13+35 on 2418B-1.
- Remove buried logs from fill between Stations 12+35 to 12+85 and 13+75 to 14+90 on 2418B-1.
- Construct non-drivable waterbars according to the attached NON-DRIVABLE WATERBAR DETAIL at a maximum spacing which will produce a vertical drop of no more than 10 feet between waterbars or between natural drainage paths and with a maximum spacing of 200 feet, or as marked in the field.
- Skew waterbars at least 30 degrees from perpendicular to the road centerline on roads in excess of 3 percent grade.
- Key waterbars into the cut-slope to intercept the ditch. Waterbars shall be outsloped to provide positive drainage. Outlets shall be on stable locations.
- Remove cross drain culvert and leave the resulting trench open. Slope all trench walls and approach embankments no steeper than 1.5:1.
- Remove stream culverts in accordance with Clause 9-2 CULVERT REMOVAL FROM LIVE STREAMS.
- Scatter woody debris onto abandon road surfaces.
- Apply grass seed concurrently with abandonment to all exposed soil within the old roadway limits and in accordance with Section 8 EROSION CONTROL.
- Provide and evenly spread a 4-inch layer of straw to all exposed soils within 100 feet of a stream.

SECTION 10 MATERIALS

10-15 CORRUGATED STEEL CULVERT

Metallic coated steel culverts must meet AASHTO M-36 (ASTM A-760) specifications. Culverts must be must be aluminized (aluminum type 2 coated meeting AASHTO M-274).

10-17 CORRUGATED PLASTIC CULVERT

Polyethylene culverts must meet AASHTO M-294 specifications, or ASTM F-2648 specifications for recycled polyethylene. Culverts must be Type S – double walled with a corrugated exterior and smooth interior.

10-21 METAL BAND

Metal coupling and end bands must meet the AASHTO specification designated for the culvert and must have matching corrugations. Culverts 24 inches and smaller must have bands with a minimum width of 12 inches. Culverts over 24 inches must have bands with a minimum width of 24 inches.

10-22 PLASTIC BAND

Plastic coupling and end bands must meet the AASHTO specification designated for the culvert. Only fittings supplied or recommended by the culvert manufacturer may be used. Couplings must be split coupling band. Split coupling bands must have a minimum of four corrugations, two on each side of the pipe joint.

10-24 GAUGE AND CORRUGATION

Metal culverts must conform to the following specifications for gage and corrugation as a function of diameter.

<u>Diameter</u>	<u>Gauge</u>	<u>Corrugation</u>
18"	16 (0.064")	2 2/3" X 1/2"
24" to 48"	14 (0.079")	2 2/3" X 1/2"

DRAFT

TYPICAL SECTION SHEET

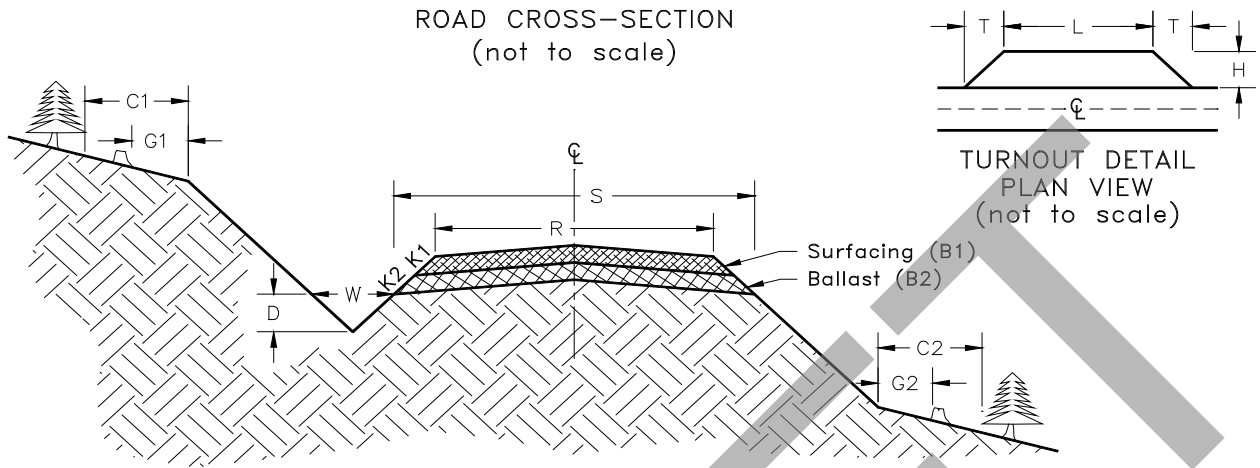

Road Number	From Station	To Station	Tolerance Class	Subgrade Width (feet)	Road Width (feet)	Ditch		Crown at CL (inches)	Grubbing Limits (feet)		Clearing Limits (feet)	
						Width (feet)	Depth (feet)		G1	G2	C1	C2
				S	R	W	D					
2400	0+00	19+46	A	16	12	3	1	4	NA	NA	NA	NA
2411	0+00	24+88	A	16	12	3	1	4	NA	NA	NA	NA
2418	0+00	137+44	A	16	12	3	1	4	NA	NA	NA	NA
2418A-1	0+00	43+00	A	16	12	3	1	4	NA	NA	NA	NA
2418A-2	0+00	24+45	A	16	12	3	1	4	NA	NA	NA	NA
2418A-3	0+00	11+62	A	16	12	3	1	4	NA	NA	NA	NA
2418B	0+00	16+86	A	16	12	3	1	4	NA	NA	NA	NA
* 2418A1-A	0+00	10+70	C	16	12	3	1	4	3	3	5	5
* 2418B-1	0+00	9+55	C	16	12	3	1	4	3	3	5	5
* 2422C-1	0+00	2+11	C	16	12	3	1	4	3	3	ROW TAGS	
* 2422C-1	2+11	10+52	C	16	12	3	1	4	3	3	5	5
* 2410C-1	0+00	10+55	C	16	12	3	1	4	3	3	5	5
* 2410C-1 EXT	0+00	5+81	C	16	12	3	1	4	3	3	ROW TAGS	
* 2410C-1 EXT	5+81	9+73	C	16	12	3	1	4	3	3	5	5

* Optional Roads

ROCK LIST
(Page 1 of 3)

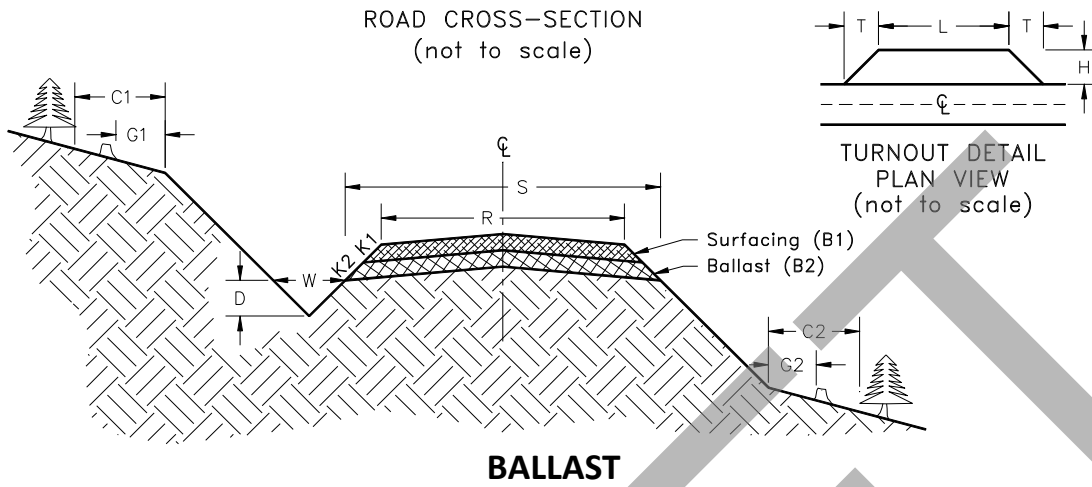

Road Number	From Station	To Station	Rock Slope	Compacted Rock Depth (inches)	C.Y./ Station	# of Stations	C.Y. Subtotal	Rock Source	Turnout		
									Length (feet)	Width (feet)	Taper (feet)
			K2	B2					L	H	T
3 INCH JAW RUN											
2418 LANDING	--	--	--	--	41/Landing	2 Landing	82	Signal Pit			
2418A-1 LANDING	--	--	--	--	41/Landing	4 Landing	164				
2418A-2 LANDING	--	--	--	--	41/Landing	4 Landing	164				
2418B LANDING	--	--	--	--	41/Landing	2 Landing	82				
2418A-3	0+00	11+62	1½:1	6	30	11.62	349				
CURVE WIDENING	--	--	1½:1	6	--	--	14				
TURNOUT JUNCTION LANDING	--	--	1½:1	6	19/TO	1 TO	19		50	10	25
		0+00	--	--	--	--	10				
	--	--	--	--	41/Landing	3 Landings	123				
2418A1-A	0+00	10+70	1½:1	9	46	10.70	492				
CURVE WIDENING	--	--	1½:1	9	--	--	20				
TURNOUT JUNCTION LANDING	--	--	1½:1	9	28/TO	1 TO	28		50	10	25
		0+00	--	--	--	--	12				
	--	--	--	--	41/Landing	2 Landings	82				

ROCK LIST
(Page 2 of 3)

BALLAST (continued)

Road Number	From Station	To Station	Rock Slope	Compacted Rock Depth (inches)	C.Y./ Station	# of Stations	C.Y. Subtotal	Rock Source	Turnout		
									Length (feet)	Width (feet)	Taper (feet)
			K2	B2					L	H	T
3 INCH JAW RUN											
2418B-1	0+00	9+55	1½:1	9	46	9.55	439	Signal Pit	50	10	25
CURVE WIDENING	--	--	1½:1	9	--	--	22				
TURNOUT	--	--	1½:1	9	28/TO	1 TO	28				
JUNCTION	0+00		--	--	--	--	12				
LANDING	--	--	--	--	41/Landing	2 Landings	82				
* 2422C-1	0+00	10+52	1½:1	12	63	10.52	663				
CURVE WIDENING	--	--	1½:1	12	--	--	27				
TURNOUT	--	--	1½:1	12	28/TO	1 TO	38				
JUNCTION	0+00		--	--	--	--	16				
LANDING	--	--	--	--	54/Landing	3 Landings	162				
2410C-1	0+00	10+55	1½:1	6	46	10.55	317	50	10	25	
CURVE WIDENING	--	--	1½:1	9	--	--	10				
TURNOUT	--	--	1½:1	6	19/TO	1 TO	19				
JUNCTION	0+00		--	--	--	--	8				
2410C-1 EXT	0+00	0	1½:1	9	46	15.94	448				
CURVE WIDENING	--	--	1½:1	9	--	--	23				
TURNOUT	--	--	1½:1	9	28/TO	1 TO	28				
LANDING	--	--	--	--	41/Landing	2 Landing	82				

* Optional Rock see Clause 6-75

Required 3 INCH JAW RUN BALLAST TOTAL **3,159** Cubic Yards
Optional 3 INCH JAW RUN BALLAST TOTAL **906** Cubic Yards

CULVERT LIST

Road Number	Location	Culvert			Armoring (Cubic Yards)			Backfill Material	Bedding Material	Culvert Marker (Y/N)	Remarks
		Dia. (inches)	Length (feet)	Type	Inlet	Outlet	Type				
2418A-1	2+20	18	36	XX	0.5	3.0	LL	NT	NT	Y	Cross drain
	9+52	18	30	XX	0.5	0.5	LL	NT	NT	Y	Cross drain, Excavate leadoff ditch @ outlet
	20+11	18	30	XX	0.5	0.5	LL	NT	NT	Y	Cross drain
2418A-2	3+01	18	30	XX	0.5	0.5	LL	NT	NT	Y	Cross drain
	10+38	18	30	XX	0.5	1.0	LL	NT	NT	Y	Cross drain
	13+85	18	30	XX	0.5	0.5	LL	NT	NT	Y	Cross drain, Excavate leadoff ditch @ outlet
2418A-3	0+25	18	30	XX	0.5	0.5	LL	NT	NT	Y	Cross drain
	3+10	18	30	XX	0.5	0.5	LL	NT	NT	Y	Cross drain, Excavate leadoff ditch @ outlet
	4+85	18	30	XX	0.5	0.5	LL	NT	NT	Y	Cross drain, Excavate leadoff ditch @ outlet
	9+65	18	30	XX	0.5	0.5	LL	NT	NT	Y	Cross drain, no skew
2418A1-A	0+00	18	44	XX	0.5	1.0	LL	NT	NT	Y	Cross drain, in existing ditchline
	1+55	24	40	XX	2.0	3.0	LL	NT	NT	Y	T-5 creek, remove buried logs prior to culvert installation
	3+05	24	34	XX	2.0	4.0	LL	NT	NT	Y	T-4 creek, remove buried logs prior to culvert installation
	6+85	18	30	XX	0.5	0.5	LL	NT	NT	Y	Cross drain, no skew
	10+70	-	-	-	-	-	-	-	-	-	Ditchout right
2418B-1	1+75	18	30	XX	0.5	0.5	LL	NT	NT	Y	Cross drain
	3+32	18	30	XX	0.5	0.5	LL	NT	NT	Y	Cross drain
2422C-1	6+41	18	30	XX	0.5	0.5	LL	NT	NT	Y	Cross drain
2410C-1 EXT	4+07	24	40	XX	2.0	4.0	LL	NT	NT	Y	T-5 creek
	4+33	18	30	XX	0.5	1.0	LL	NT	NT	Y	Cross drain
	5+81	18	30	XX	0.5	0.5	LL	NT	NT	Y	Cross drain
	7+35	18	30	XX	0.5	0.5	LL	NT	NT	Y	Cross drain
	7+73	24	40	XX	2.0	3.0	LL	NT	NT	Y	T-5 creek
	8+09	18	30	XX	0.5	1.0	LL	NT	NT	Y	Cross drain
	8+73	24	40	XX	2.0	4.0	LL	NT	NT	Y	T-5 creek
	9+24	18	30	XX	0.5	2.0	LL	NT	NT	Y	Cross drain

Key:

- CR - Crushed Rock – 1 ¼ " minus
- NT - Native (bank run)
- LL - Light Loose Riprap
- PD - Polyethylene Pipe Dual Wall
- AM - Aluminized Metal
- XX - PD or AM

COMPACTION LIST

Road	From Station	To Station	Type	Max Depth Per Lift (inches)	Equipment Type	Equipment Weight (lbs)	Minimum Number of Passes	Maximum Operating Speed (mph)
All Waste Areas	All	All	Waste Area	12	Excavation	28,000	3	--
All roads	All	All	Embankment	12	Excavation	28,000	4	--
All roads	All	All	Subgrade	12	Vibratory Smooth Drum	20,000	4	5
All roads	All	All	3 Inch Jaw Run Rock	12	Vibratory Smooth Drum	20,000	4	5
All roads	All	All	1 ¼ Inch Minus Crushed Rock	6	Vibratory Smooth Drum	20,000	4	5

DRAFT

CULVERT AND DRAINAGE SPECIFICATION DETAIL
PAGE 1 OF 2

INSTALLATION REQUIREMENTS:

1. Proper preparation of foundation and placement of any required bedding material shall precede the installation of all culverts. This includes necessary leveling of the native trench bottom and compaction of required bedding material to form a uniform, dense, unyielding base. The pipe must be uniformly supported along the barrel.
2. Backfill material shall be compacted under the culvert haunches, around the sides, and above the culvert in accordance with the COMPACTION LIST.

ALL DRAWINGS ARE NOT TO SCALE

CROSS SECTION

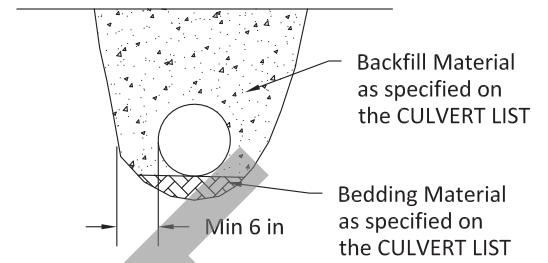

CULVERT PROFILE (TYPICAL)

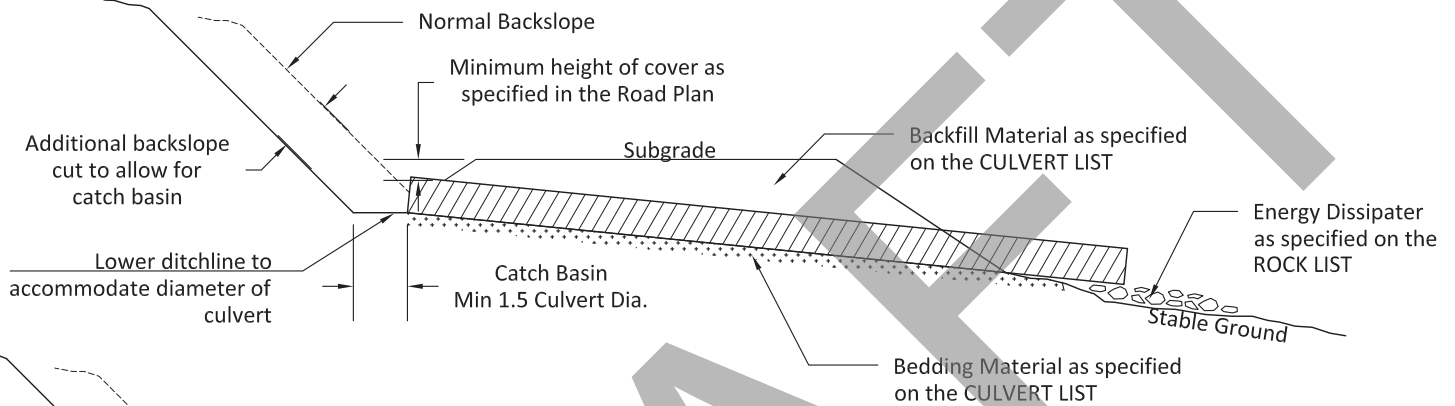

CULVERT WITH DOWNSPOUT OPTION 1

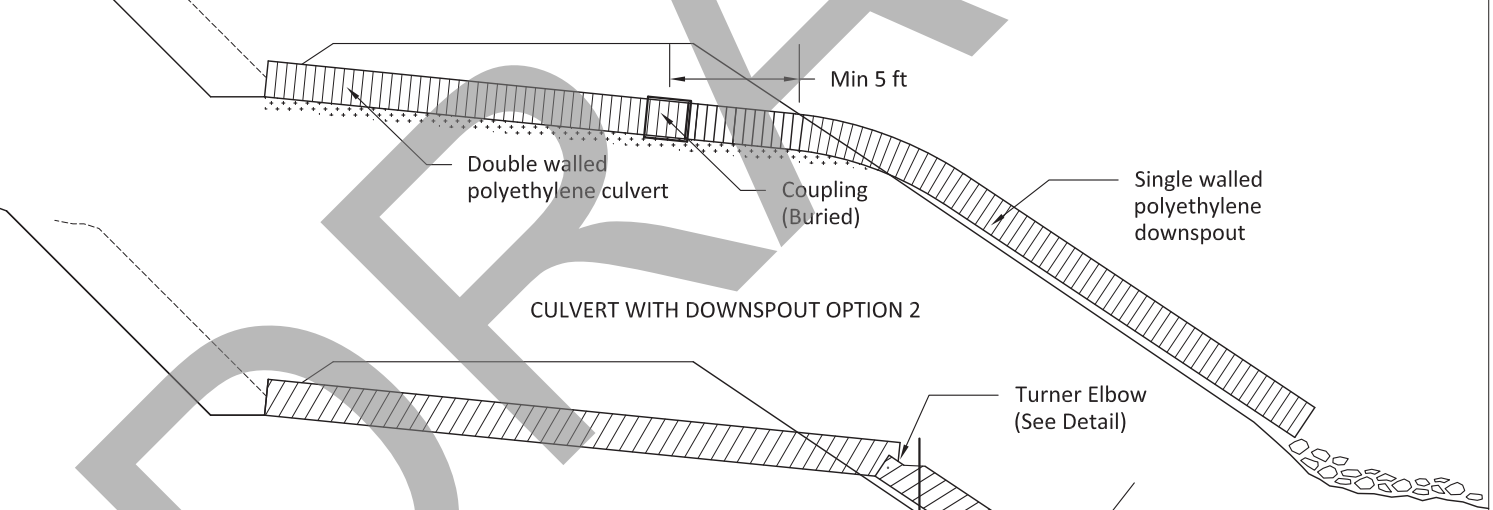

CULVERT WITH DOWNSPOUT OPTION 2

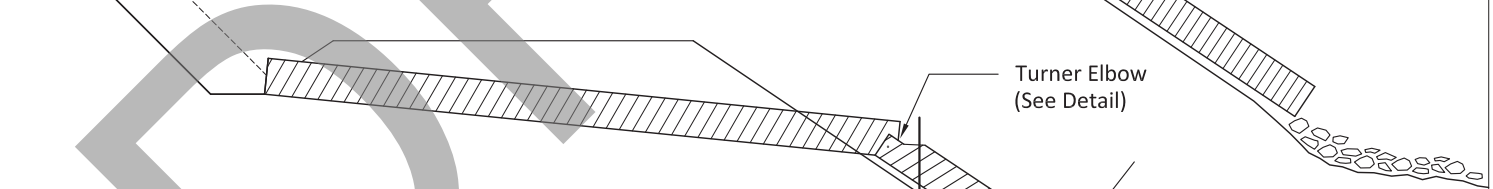

SUPPORT STAKES

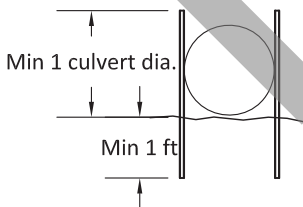

Stake Material: T-post with rust protection coating.
Connections: Bolt support stakes to the culvert with $\frac{5}{8}$ " u-bolts, with washers on both the inside and outside of the culvert.
Alternative staking methods may be approved, in writing, by the Contract Administrator.

TURNER ELBOW

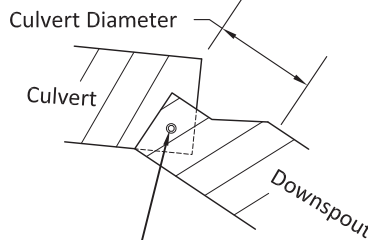

Bolted with $\frac{5}{8}$ " galvanized bolts and washers (both sides)
Downspout must be 6 inches larger in diameter than the culvert.

Support Stakes (See Detail)

CULVERT AND DRAINAGE SPECIFICATION DETAIL
PAGE 2 OF 2

HEADWALLS

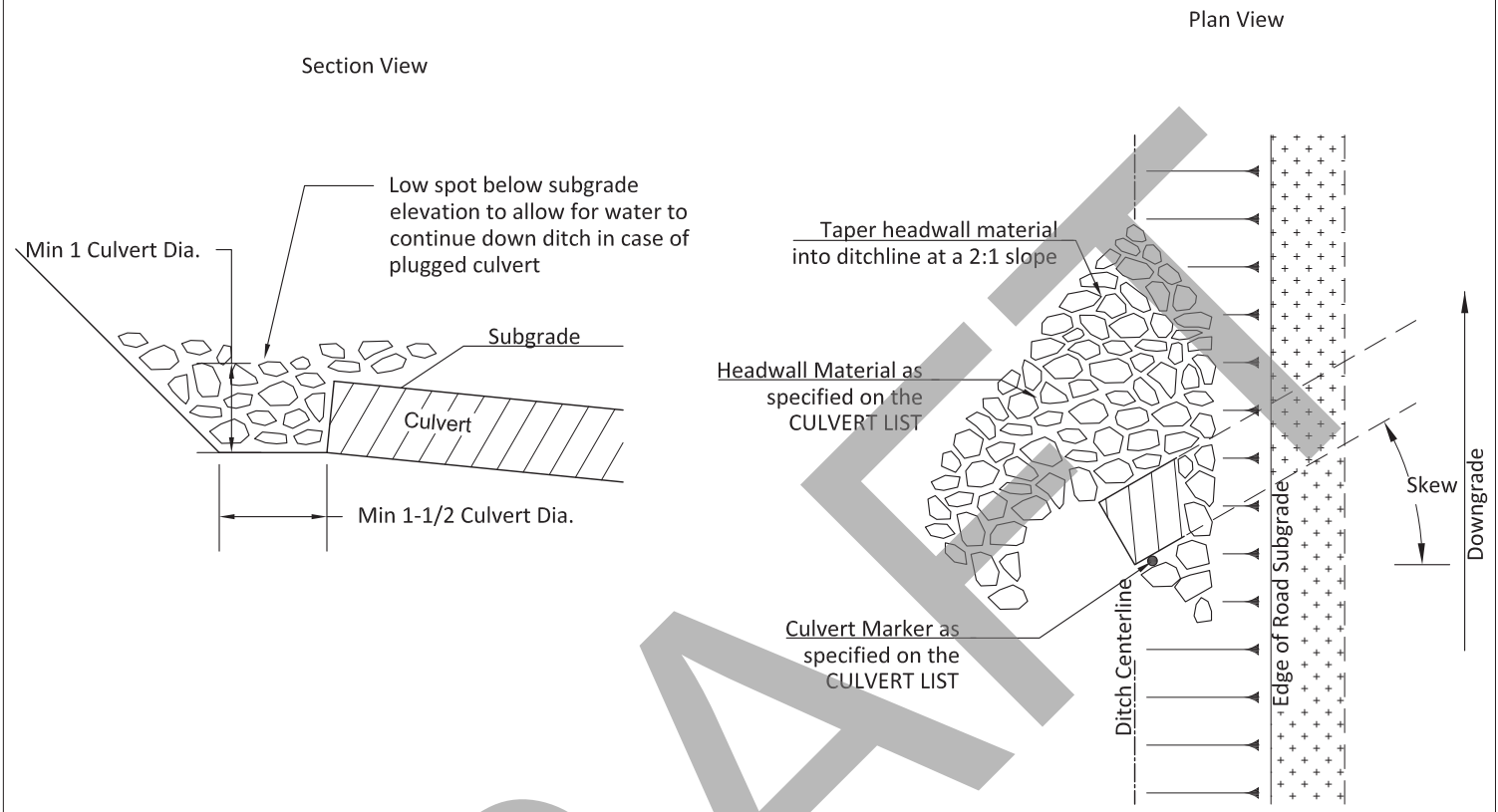

CULVERT MARKERS

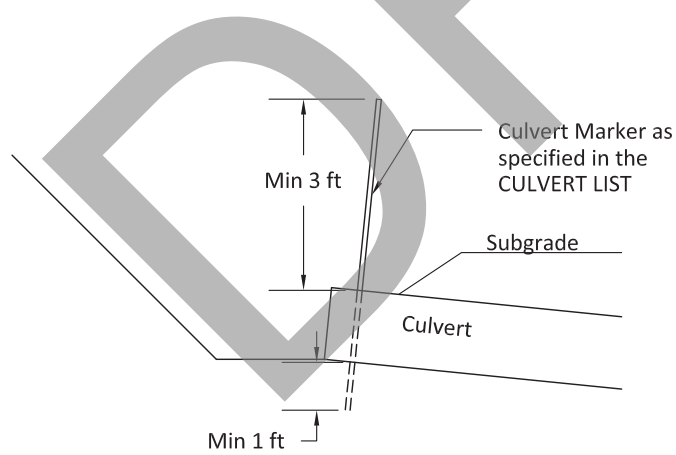

Culvert Marker Material: 1 Inch I.D., Schedule 40 PVC Pipe, White. Marker must be capped on the top.
 Culvert Marker Placement: Place on uphill side of culvert, between corrugations if possible.
 Alternative culvert marker types may be approved, in writing, by the Contract Administrator.

ENERGY DISSIPATORS

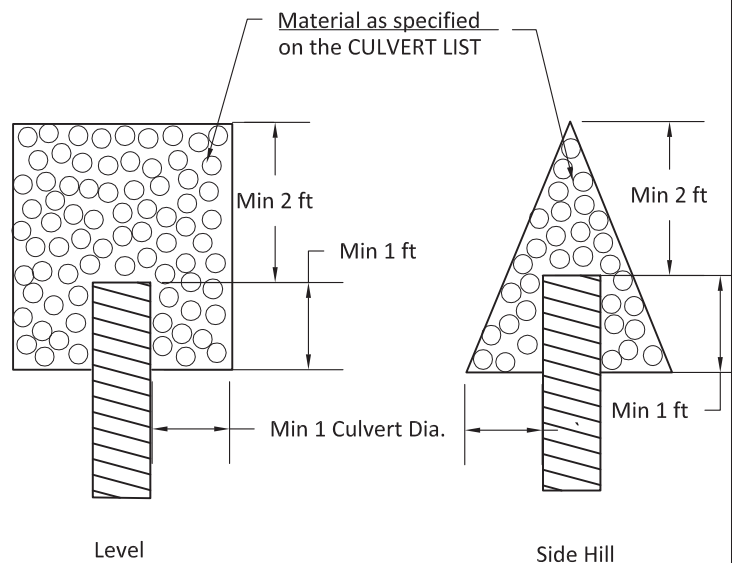

Min Energy Dissipater Depth: 1 Culvert Dia.

FOREST ACCESS ROAD MAINTENANCE SPECIFICATIONS

Page 1 of 2

Cuts and Fills

- Maintain slope lines to a stable gradient compatible with the cut slope/fill slope ratios. Remove slides from ditches and the roadway. Repair fill-failures, in accordance with Clause 4-6 EMBANKMENT SLOPE RATIO, with selected material or material approved by the Contract Administrator. Remove overhanging material from the top of cut slopes.
- Waste material from slides or other sources shall be placed and compacted in stable locations identified in the road plan or approved by the Contract Administrator, so that sediment will not deliver to any streams or wetlands.
- Slide material and debris shall not be mixed into the road surface materials, unless approved by the Contract Administrator.

Surface

- Grade and shape the road surface, turnouts, and shoulders to the original shape on the TYPICAL SECTION SHEET to provide a smooth, rut-free traveled surface and maintain surface water runoff in an even, unconcentrated manner.
- Blading shall not undercut the backslope or cut into geotextile fabric on the road.
- If required by the Contract Administrator, water shall be applied as necessary to control dust and retain fine surface rock.
- Surface material shall not be bladed off the roadway. Replace surface material when lost or worn away, or as directed by the Contract Administrator.
- Remove shoulder berms, created by grading, to facilitate drainage, except as marked or directed by the Contract Administrator.
- For roads with geotextile fabric: spread surface aggregate to fill in soft spots and wheel ruts (barrel spread) to prevent damage to the geotextile fabric.

Drainage

- Prevent silt bearing road surface and ditch runoff from delivering sediment to any streams or wetlands.
- Maintain rolling dips and drivable waterbars as needed to keep them functioning as intended.
- Maintain headwalls to the road shoulder level with material that will resist erosion.
- Maintain energy dissipaters at culvert outlets with non-erodible material or rock.
- Keep ditches, culverts, and other drainage structures clear of obstructions and functioning as intended.
- Inspect and clean culverts at least monthly, with additional inspections during storms and periods of high runoff. This shall be done even during periods of inactivity.

Preventative Maintenance

- Perform preventative maintenance work to safeguard against storm damage, such as blading to ensure correct runoff, ditch and culvert cleaning, and waterbar maintenance.

Termination of Use or End of Season

- At the conclusion of logging operations, ensure all conditions of these specifications have been met.

Debris

- Remove fallen timber, limbs, and stumps from the slopes, roadway, ditchlines, and culvert inlets.

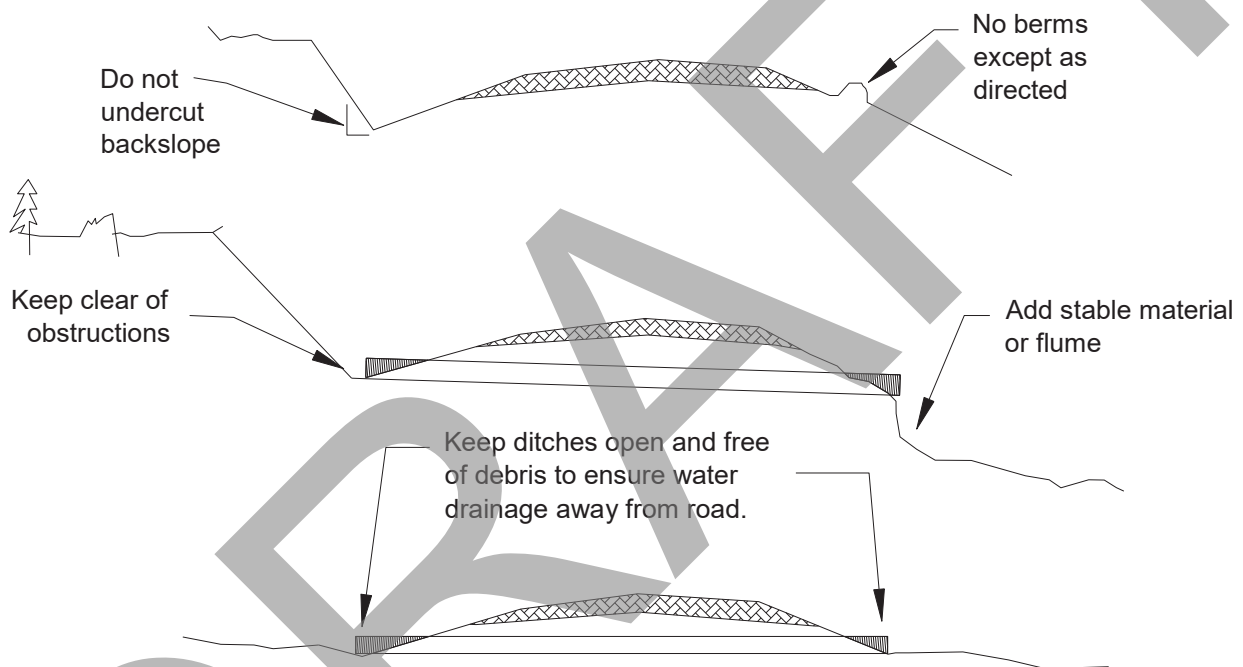

LIVE STREAM INSTALLATION PROCEDURE

Order of work is as follows, deviations shall be approved, in writing, by the Contract Administrator.

- 1) Purchaser shall notify the State of intent to start project, and a pre-work conference shall be held before move in of equipment. State will designate a representative that will remain on site at all times when work is being performed in creek channel.
- 2) Work period shall be restricted to the permitted times stated in an approved FPA. Work period on Np and Ns streams that are not covered by an FPA shall be permitted only during the dry weather seasonal low flow period between June 1 and October 1; any work outside of this timing restriction may be granted in writing by the Contract Administrator only during unseasonably low flows.
- 3) Assemble the items on the Materials List onsite before proceeding.
- 4) Set up pumps (one as backup).
- 5) Dam up stream with sandbags and line floor of dam with plastic (to prevent sub-surface water flow), place clean rock on plastic to hold in place, and key leading edge of plastic into channel bottom - see SETTLING POND AND PUMP DETAIL. Build a settling pond at culvert outlet. Fill may need to be removed before the settling pond installation due to space limitations. Pump clean water at catch basin around work site and back into stream. Dirty water shall be pumped away from site and onto forest floor a minimum of 200 feet from live streams. Silt fence shall be erected at base of fill slope and bottom edge of fence shall be keyed into slope and held in place with rocks to prevent water from flowing under the silt fence.
- 6) Remove remainder of fill and culvert.
- 7) Remove settling pond.
- 8) Cover exposed soils within 100 feet of all live streams with straw (minimum depth of 4 inches) and grass seed.

Materials List:

- 3 pumps, (one as a backup) The clean water pump (dam at culvert catch basin) shall have a minimum capacity of 1200 gallons per minute. The dirty water pump (settling pond) and the backup pump shall each have a minimum capacity of 600 gpm. Culvert removal should not start during rain or threat of rain;
- plastic sheet;
- silt fence and stakes;
- bales of straw

LIVE STREAM REMOVAL PROCEDURE

Order of work is as follows, deviations shall be approved, in writing, by the Contract Administrator.

- 1) Purchaser shall notify the State of intent to start project, and a pre-work conference shall be held before move in of equipment. State will designate a representative that will remain on site at all times when work is being performed in creek channel.
- 2) Work period shall be restricted to the permitted times stated in an approved FPA. Work period on Np and Ns streams that are not covered by an FPA shall be permitted only during dry weather and seasonal low flow period between June 1 and October 1; any work outside of this timing restriction may be granted in writing by the Contract Administrator only during unseasonably low flows.
- 3) Assemble the items on the Materials List onsite before proceeding.
- 4) Set up pumps (one as backup).
- 5) Dam up stream with sandbags and line floor of dam with plastic (to prevent sub-surface water flow), place clean rock on plastic to hold in place, and key leading edge of plastic into channel bottom - see SETTLING POND AND PUMP DETAIL. Build a settling pond at culvert outlet. Fill may need to be removed before the settling pond installation due to space limitations. Pump clean water at catch basin around work site and back into stream. Dirty water shall be pumped away from site and onto forest floor a minimum of 200 feet from live streams. Silt fence shall be erected at base of fill slope and bottom edge of fence shall be keyed into slope and held in place with rocks to prevent water from flowing under the silt fence.
- 6) Remove 95% of fill (see FILL REMOVAL DETAIL). Excavated channel slopes shall be consistent with requirements stated in Clauses 9-2, 9-22 and 9-24.
- 7) Remove remainder of fill, logs from fill, and any culverts.
- 8) Remove settling pond.
- 9) Cover exposed soils within 100 feet of all live streams with weed free straw (minimum depth of 4 inches) and grass seed.

Materials List:

- 3 pumps, (one as a backup) The clean water pump (dam at culvert catch basin) shall have a minimum capacity of 1200 gallons per minute. The dirty water pump (settling pond) and the backup pump shall each have a minimum capacity of 600 gpm. Culvert removal should not start during rain or threat of rain;
- plastic sheet;
- silt fence and stakes;
- bales of weed free straw

FILL REMOVAL DETAIL

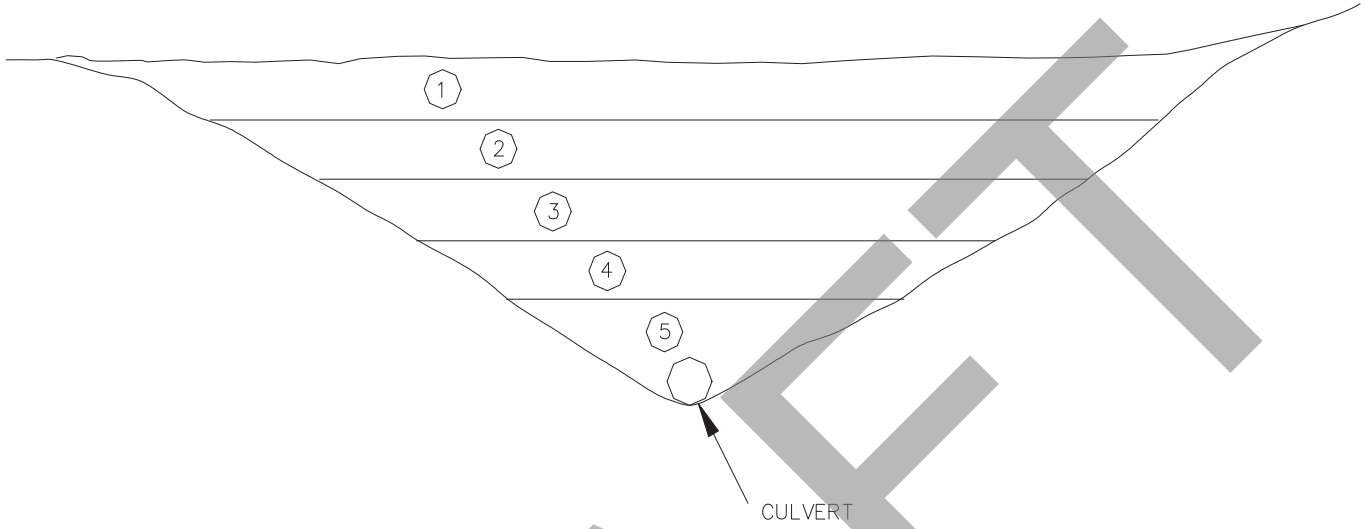

- Remove fill in layers not to exceed 3 feet.

TYPICAL ABANDONED/DEACTIVATED STREAM CROSSING PLAN VIEW

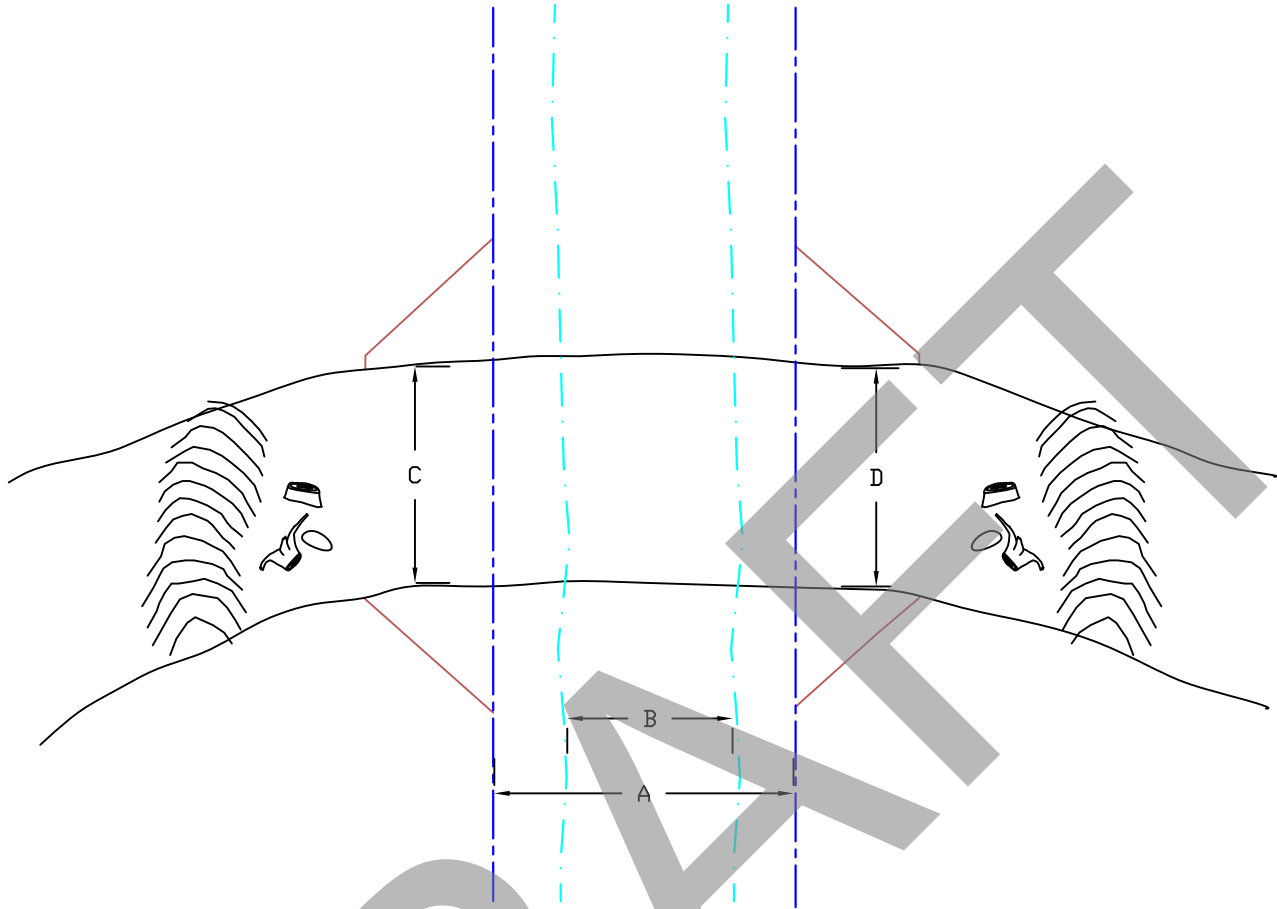

- A = Total Fill Removal Width
- B = Bank Full Width
- C = Road With
- D = Road With

SETTLING POND AND PUMP DETAIL

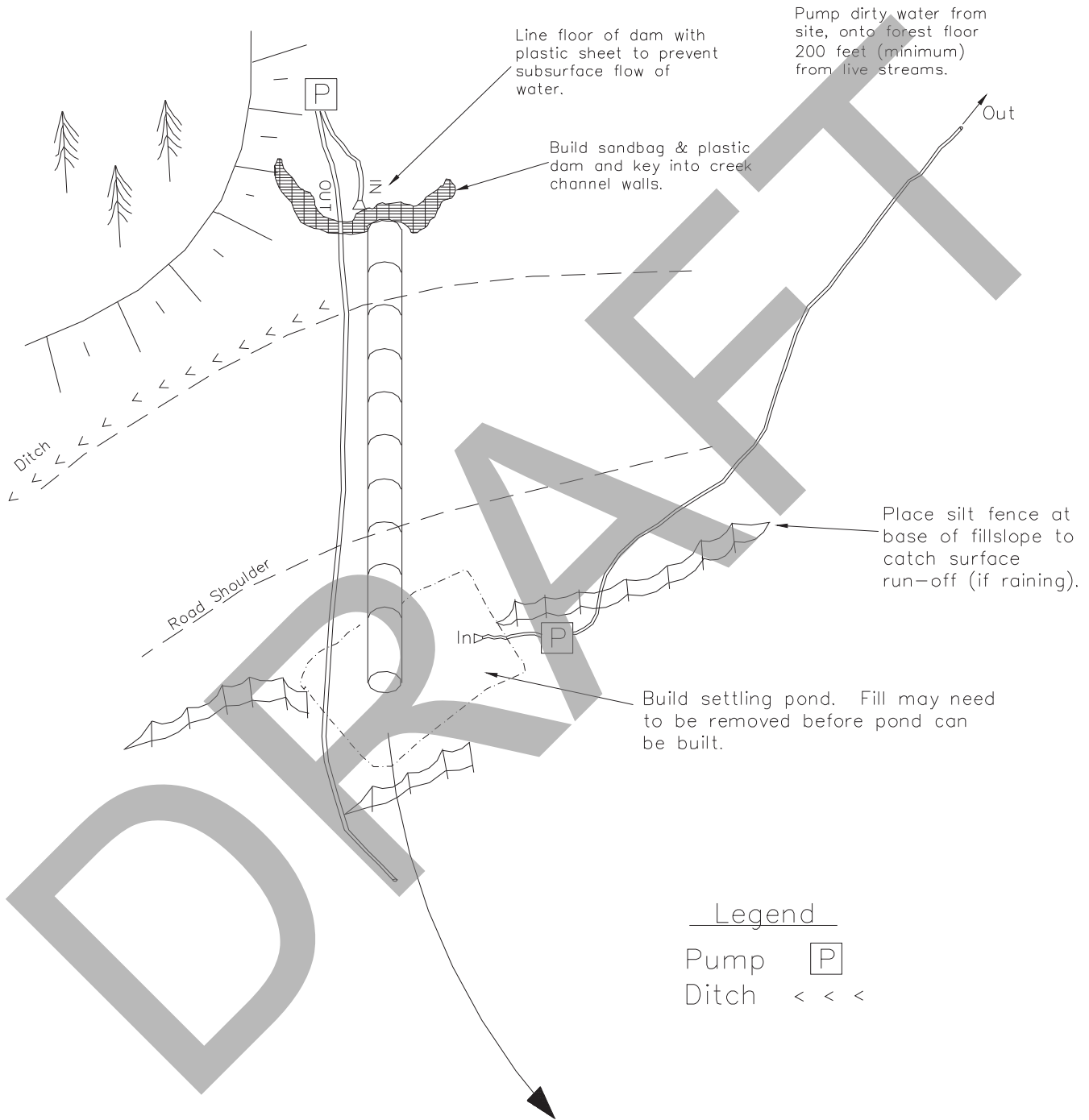

SEDIMENT TRAP DETAIL

No Scale

TYPICAL PLAN VIEW

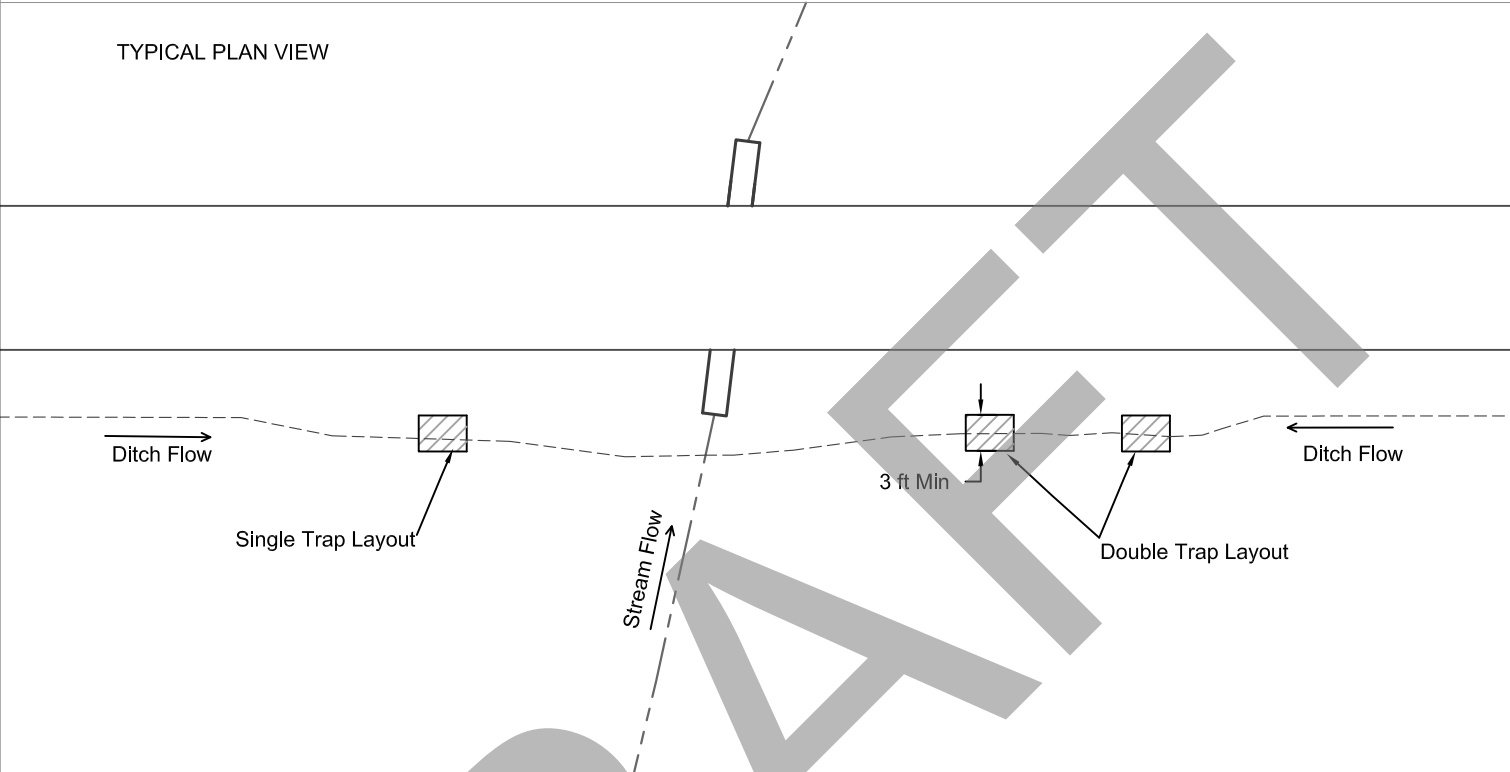

TYPICAL PROFILE

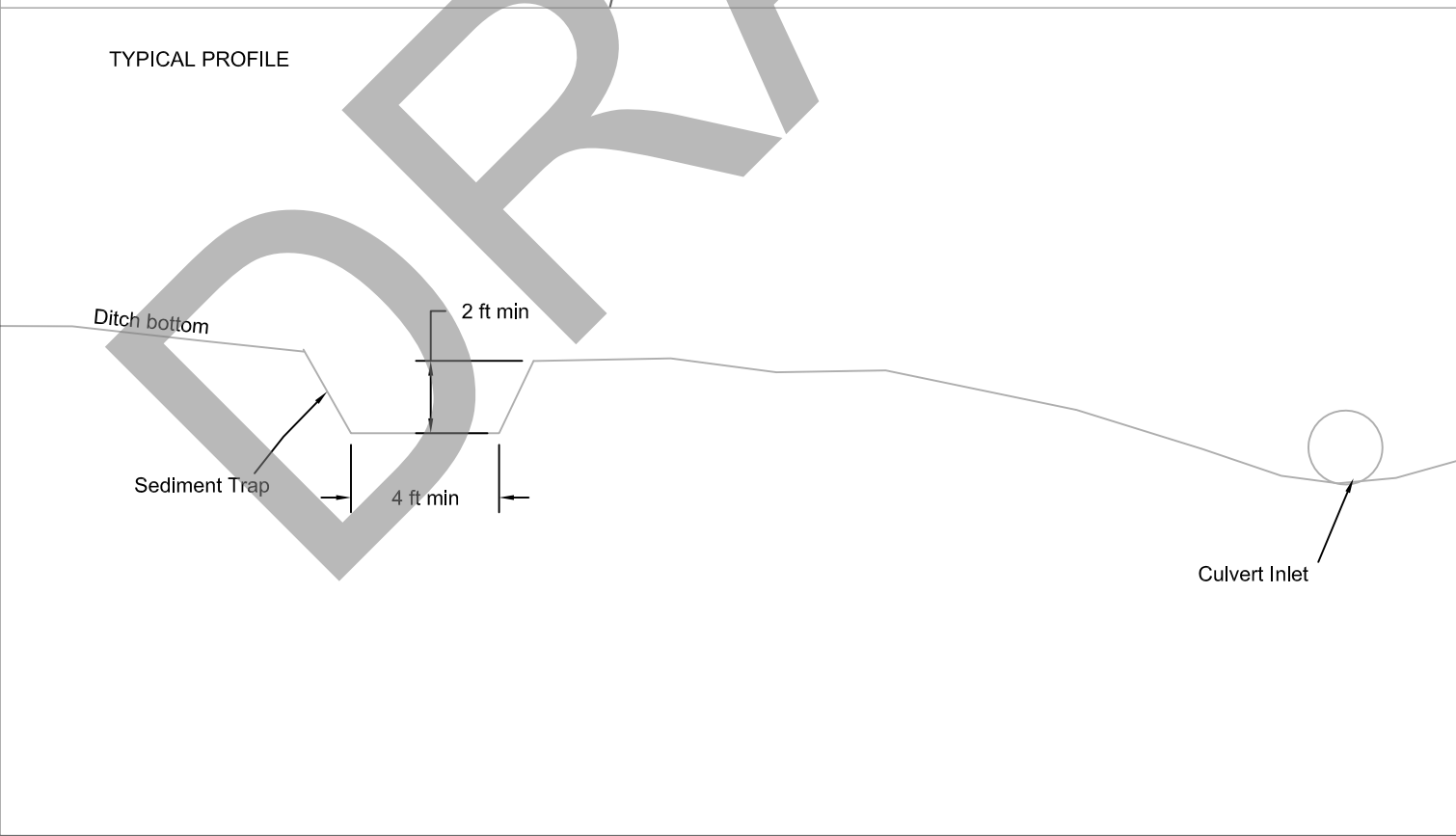

EARTHEN BARRICADE DETAIL

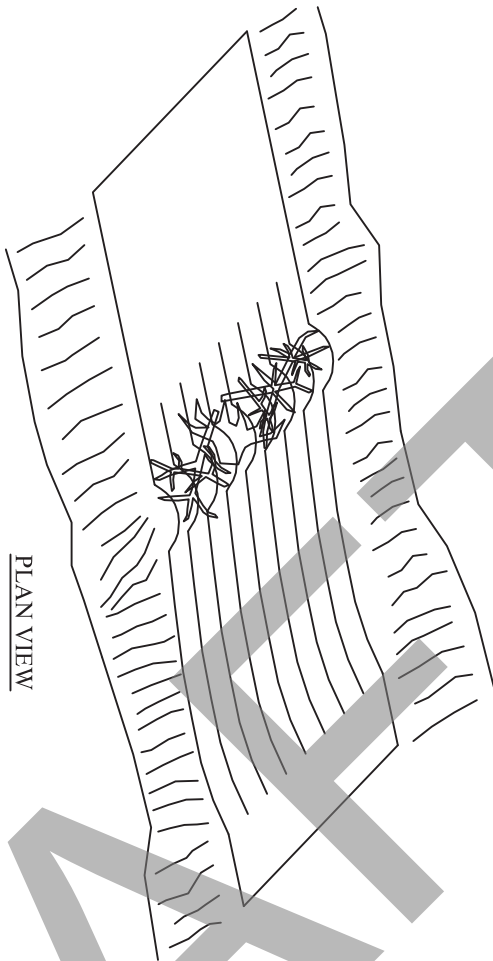

SLASH AND ROOT WADS SHALL BE INCORPORATED INTO THE TRAFFIC SIDE OF THE BARRICADE.

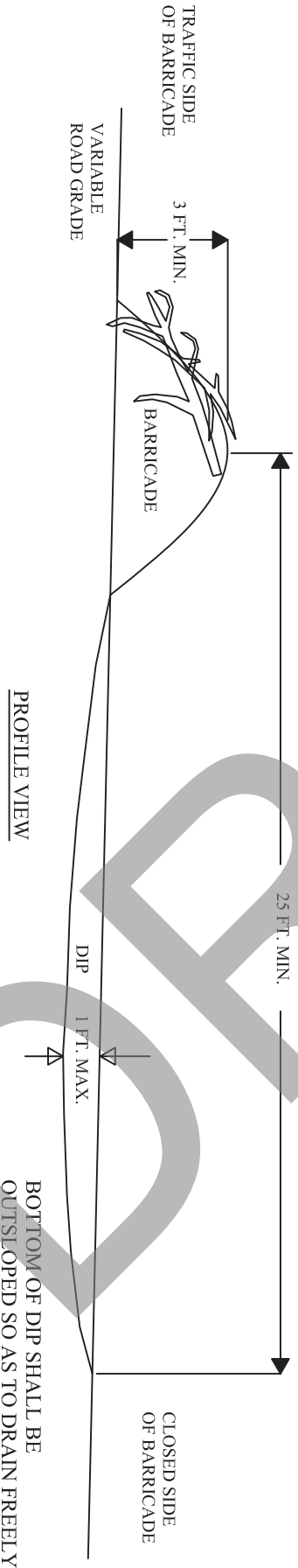

ROAD ABANDONMENT CROSS SECTIONS

LIGHT

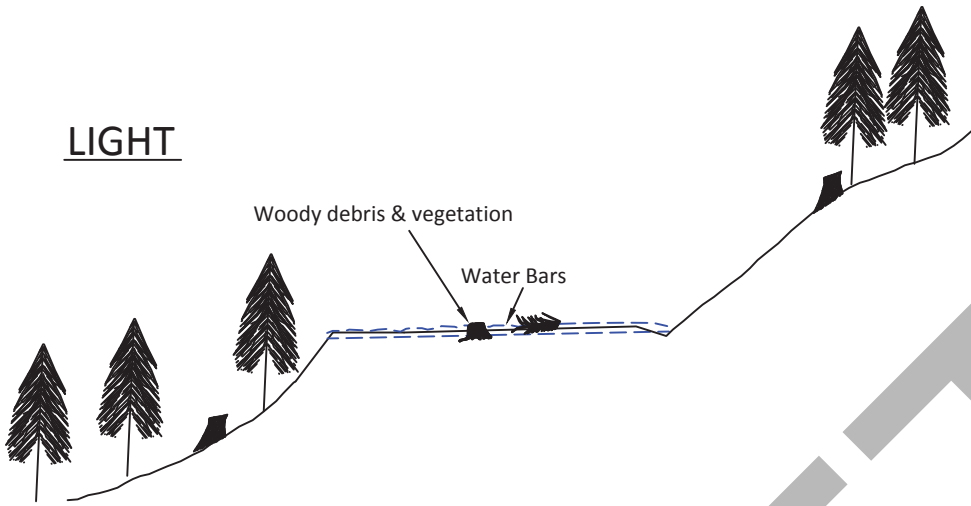

MEDIUM

Woody debris & vegetation

Remove

Fill

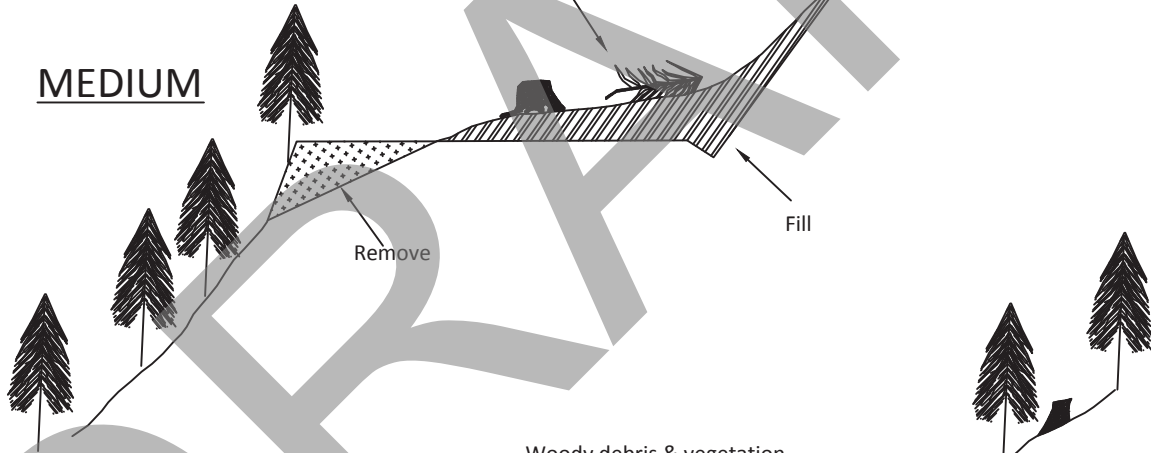

Woody debris & vegetation

HEAVY

Remove

Fill

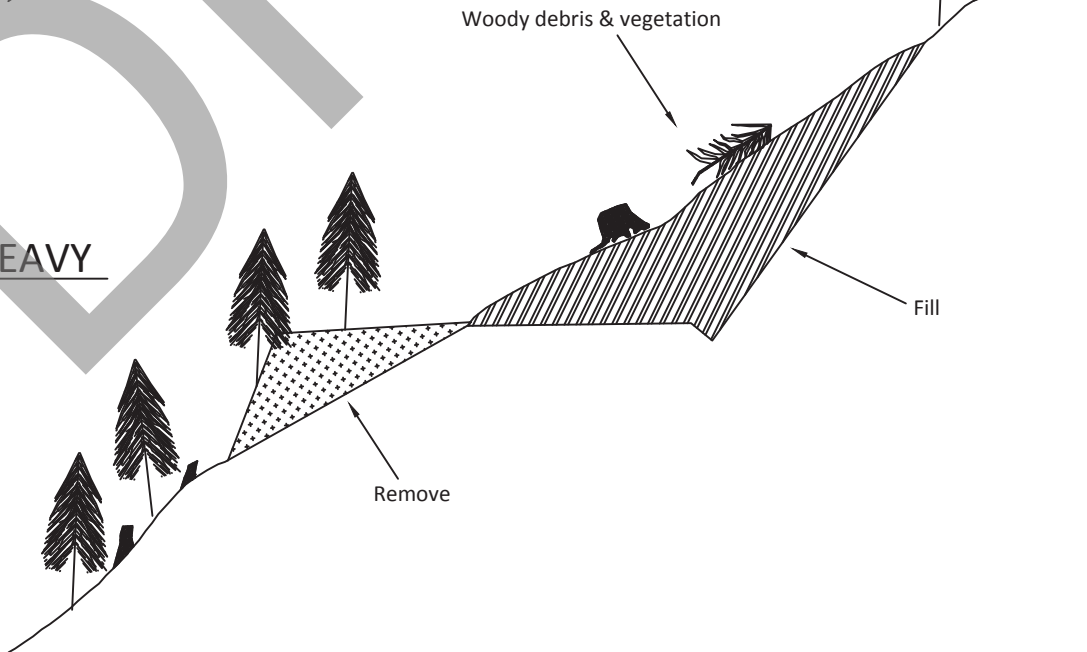

NON-DRIVABLE WATER BAR DETAIL

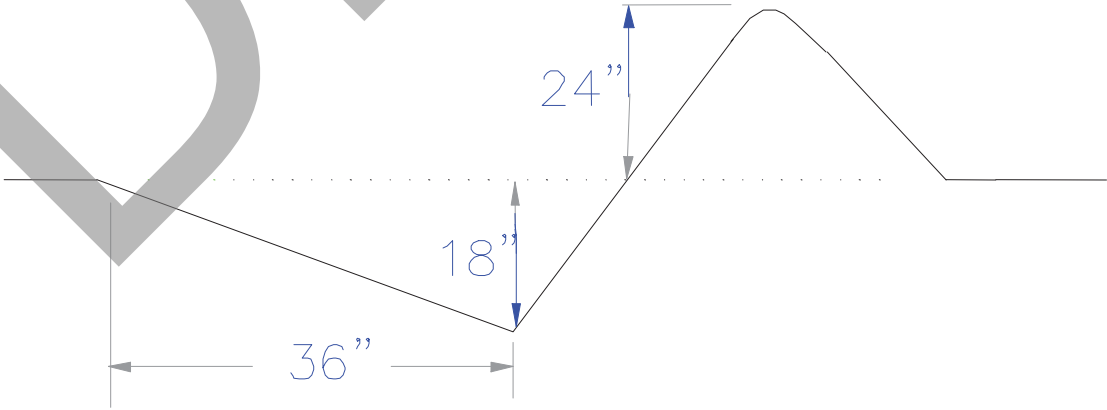
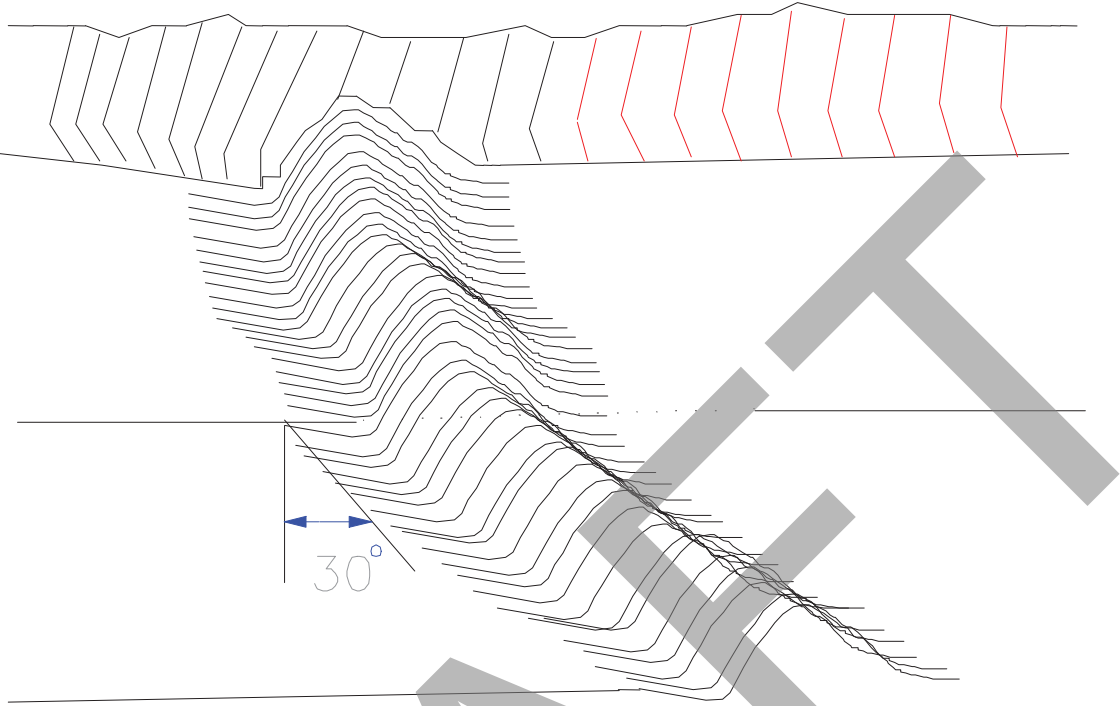

ROCK ACCOUNTABILITY DETAIL

SALE NAME: _____

Purchaser: _____

Agreement #: _____

Contractor: _____

Rock Quarry/Pit: _____

Truck No: _____

DAILY ROCK LOAD RECORD

DATE	LOAD TIME	<u>ROAD NO.</u>	TYPE OF ROCK	QUANTITY	COMMENTS

Truck Driver Signature

_____ SIGNATURE

_____ DATE

Rock Crushing Compliance Procedure

Phase I. Equipment Adjustment

- Step 1:** At start up of crushing operations, the contractor will notify the contract administrator when the rock meets the gradation specifications in the contract. None of the rock crushed during this calibration period will be counted toward the amount required to be crushed, and this rock must be kept separate from accepted rock crushed later.
- Step 2:** The contract administrator and the contractor will test the rock. Two samples will be taken. If the rock meets specifications, crushing may begin. If the rock does not meet specifications, return to Step 1.

Phase II. Production

- Step 3:** The contract administrator and the contractor will continue periodic testing to ensure that rock stays in spec. Testing will take place according to the following schedule:
- After the first 500 yards
 - After every 1,000 yards thereafter
- a) Any time a sample is out of spec, but is within 5%*, the contractor will be notified and a second sample will be taken later in the day. If the second sample meets specifications, the rock crushed during that day will be accepted. If the second sample also fails to meet spec, none of the rock crushed since the last acceptable test will be counted toward the amount to be crushed.
- b) Any time a sample is out of spec and is more than 5% off in any category, none of the rock crushed since the last acceptable test will be accepted and that rock must be kept separate from the stockpile. Return to Step 1.
- c) Contractors are strongly encouraged to take their own samples regularly and keep their operations in spec to avoid unnecessary expenses.
- * The 5% will be applied only to sieve specs for 2" to ¼"; rock that is out of spec in larger sizes must be kept separate from the acceptable rock.

STATE OF WASHINGTON
DEPARTMENT OF NATURAL RESOURCES
PACIFIC CASCADE REGION

INFORMATIONAL BLASTING PLAN

Timber Sale/Project Name: _____ App./Project No.: _____

1. Blaster-in-Charge: Name: _____

Company: _____

Address: _____

Telephone: _____

2. Quarry Name/Location: _____

3. Total Estimated Cubic Yards in Blast (loose): _____

4. Hole Spacing: _____

5. Burden: _____

6. Hole Diameter: _____

7. Hole Depth: _____

8. Sub Drill: _____

9. Number of Holes: _____

10. Stemming Depth: _____

11. Explosive (mfg., name, density, %, V.O.D.): _____

12. Type and Size of Primer (if applicable): _____

13. Total Weight of Primers for Shot: _____

14. Calculated Powder Factor/Cubic Yard: _____

15. Number of Delays (in M.S.): _____

M-126PAC (03/04)

INFORMATIONAL BLASTING PLAN

Page 2 of 3

16. Number of Holes Fired on Each Delay: _____

17. Total Amount of Explosives Fired on Each Delay: _____

18. Type of Blasting Machine: _____

19. Date, Start Drilling: _____

20. Date and Time, Start Loading: _____

21. Date and Time of Blast (approx.): _____

DRAFT

22. Detail drawing of delay system (show hole pattern and delays in milliseconds). Attach additional sheets if required:

23. Typical cross-section of hole (show primer, main charge, sub drill, and stemming):

23. Submitted by: _____ Date: _____

24. Received by: _____ Date: _____

Note: Attach copies of manufacturer=s data sheet(s) for explosive and caps.

M-126PAC (03/04)

STATE OF WASHINGTON
DEPARTMENT OF NATURAL RESOURCES
PACIFIC CASCADE REGION

ROCK SOURCE DEVELOPMENT PLAN

Signal Pit – SW¼ Section 03, Township 09 North, Range 02 East, W.M.
(Page 1 of 2)

1. Development shall take place in mining area as indicated on the Rock Source Development Plan Map for the Signal Pit.
2. All vegetation including stumps shall be cleared a minimum of 25 feet beyond the top of all working faces. Trees shall be cleared to a minimum of ¾ of the height of the tallest tree adjacent to the pit. The Contractor shall maintain a minimum of 15 foot wide area stripped to rock from the pit face at all times. All Clearing shall be approved in writing by the Contract Administrator prior to overburden removal.
3. Overburden from the Signal Pit shall be end hauled to the waste area at Station 3+70 on the 4253F road. All waste material shall be compacted. Minimal acceptable compaction is achieved by placing waste material in 1 foot or shallower lifts and routing excavation equipment over entire width of the lifts. All Overburden removal shall be approved in writing by the Contract Administrator prior to any drilling operation and or rock extraction.
4. Root wads and organic debris larger than one cubic foot in volume shall be separated from overburden material and piled in the designated Waste Area.
5. The Operator shall submit an informational drilling and shooting plan to the Contract Administrator 5 working days prior to any drilling. (Form #M-126PAC)
6. Drilling may begin when the Contract Administrator has approved, in writing, all of the Clearing, Grubbing and Overburden removal. Purchaser shall block access roads and trails before blasting operations.
7. Pit faces shall not exceed 30 feet in height. All pit faces shall be sloped no steeper than ¼:1.
8. Working bench width shall be a minimum of 20 feet.
9. The pit floor shall have continuity of slope and be left in a smooth and neat condition, providing drainage at a minimum of 2 percent. All knobs, bumps, or extrusions shall be removed to the designated floor level by excavation or drill and shoot techniques. The installation of a culvert may be necessary to drain water from the pit floor in locations where the pit floor is adjacent to a road. The location of the culvert shall be subject to approval of the Contract Administrator. No sediment shall enter live water.
10. The location and amount of material to be placed in a temporary stockpile are subject to approval of the Contract Administrator. All stock piled material shall be maintained in a neat and useable condition.
11. Oversize material remaining in the rock source at the conclusion of use shall not exceed 5 percent of the total volume mined during that operation. Oversize material is defined as rock fragments larger than two feet in any direction and not larger than two cubic yards in volume. At the conclusion of operations, all remaining oversize material shall be placed at the location shown on the Pit Development Plan Map and as directed by the Contract Administrator in a location outside of the future development.
12. At the end of operations, pit faces and walls shall be scaled and cleared of loose and overhanging material and shall not be undermined or over steepened; benches shall have safety berms constructed or access blocked to highway vehicles. Access roads/trails shall have Non-driveable waterbars constructed in accordance with the NON-DRIVEABLE WATER BAR DETAIL as directed by the Contract Administrator. Upon completion of operations in the pit, the area will be left in a condition that will not endanger public safety, damage property, or be hazardous to human life.
13. All exposed soil in the waste area, access roads, and exposed banks shall be grass seeded in accordance with Road Plan Clauses 8-15 and 8-25.
14. All operations shall be carried out in compliance with all regulations of:
 - a. Regulations and Standards Applicable to Metal and Nonmetal Mining and Milling Operations (30 CFR) U.S. Department of Labor, Mine Safety and Health Administration.
 - b. "Safety Standards for Construction Work" (296-155 WAC), Washington Department of Labor and Industries.
15. The Operator shall submit an informational drilling and shooting report to the Contract Administrator after blasting has occurred. (Form #M-126PAC)
16. The pit area shall be worked and left in a condition that future operations may proceed in an orderly manner. Upon completion of operations, the site shall be cleared of all temporary structures/equipment and rubbish, access roads shall be blocked with riprap at locations as directed by the Contract Administrator, and shall be left in a neat and presentable condition. At the completion of rock source operations, Contractor shall ask Contract Administrator for written approval of final rock source condition and compliance with the terms of this plan.

SIGNAL PIT

SW1/4 Sec. 3, T09N, R02E, W.M.

(Page 2 of 2)

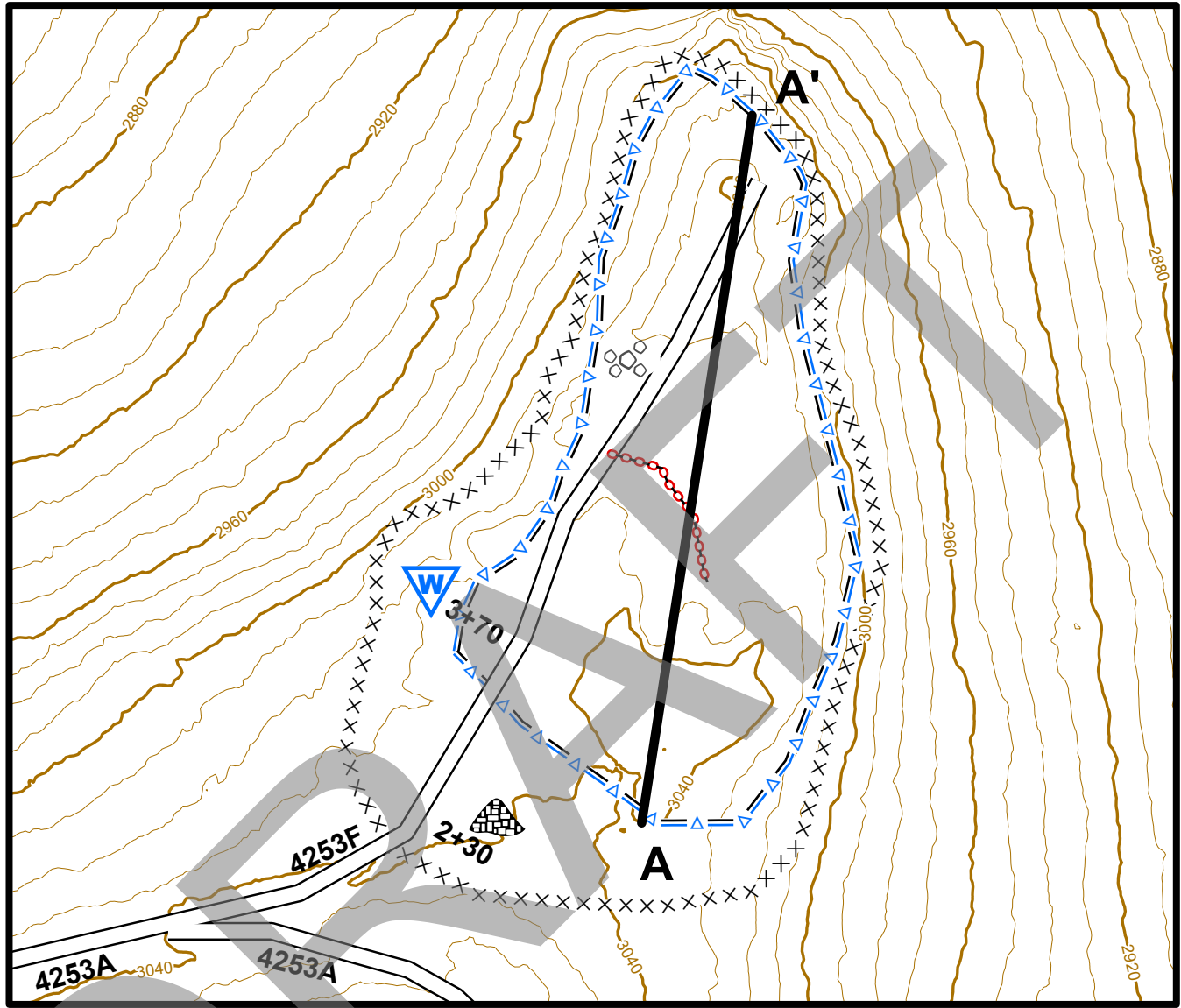

Legend

- Signal Rock Pit**
- ⋯⋯⋯ Access Road
- Existing Roads
- =△= Mining Area
- ××× Rock Pit Boundary
- Contours 40 ft
- Contours 10 ft
- Profile Line
- Oversize Rock Storage Area
- ▽ Waste Area
- ▨ Stockpile Area

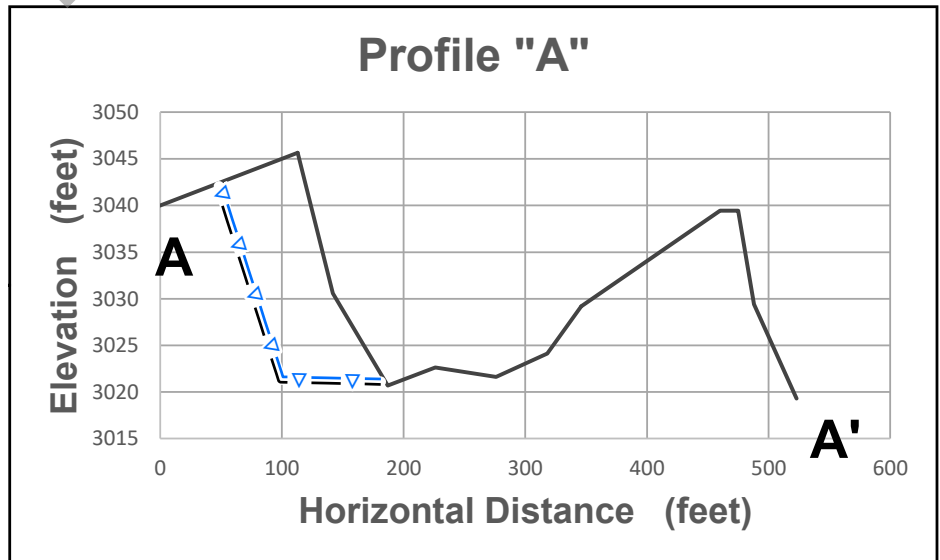
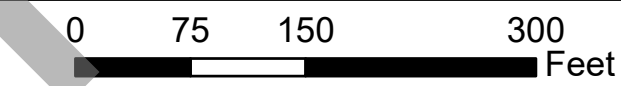

SUMMARY - Road Development Costs

REGION: Pacific Cascade

DISTRICT: Saint Helens

SALE/PROJECT NAME: Ghost Town Sorts

AGREEMENT #: 30-104392

ROAD NUMBERS:	2422C-1, & 2410C-1 EXT	2418A1-A, 2418B-1, & 2410C-1	2400, 2411, 2418, 2418A-1, 2418A-2, 2418A-3, & 2418B
---------------	---------------------------	------------------------------------	---

ROAD STANDARD:	Construction	Reconstruction	Maintenance
NUMBER OF STATIONS:	20.25	30.80	277.71

CLEARING & GRUBBING, EXCAVATION AND FILL, MISC., & ADDITIONAL REQUIREMENTS:	\$8,610.74	\$8,424.45	\$19,622.60
--	------------	------------	-------------

ROAD ROCK:	Optional:	\$24,563.62	\$0.00
	Required:	\$20,705.09	\$47,840.46
	Total:	\$45,268.71	\$62,077.54

STOCKPILE/PIT DEVELOPMENT:	\$0.00	\$0.00	\$14,650.00
----------------------------	--------	--------	-------------

CULVERTS AND FLUMES:	\$8,006.58	\$5,532.52	\$7,732.30
----------------------	------------	------------	------------

STRUCTURES:	\$0.00	\$0.00	\$0.00
-------------	--------	--------	--------

DUST ABATEMENT	\$0.00	\$0.00	\$0.00
----------------	--------	--------	--------

MOBILIZATION:	\$1,561.80	\$1,735.34	\$2,487.32
---------------	------------	------------	------------

TOTAL COSTS:	\$63,447.83	\$63,532.77	\$106,569.76
--------------	-------------	-------------	--------------

COST PER STATION:	\$3,133	\$2,063	\$384
-------------------	---------	---------	-------

ROAD DEACTIVATION & ABANDONMENT COSTS:	\$0.00	\$5,254.61	\$0.00
---	--------	------------	--------

10% OVERHEAD AND GENERAL EXPENSE =	\$23,880.50
TOTAL (All Roads) =	\$262,685.47
TOTAL (Minus Optional Rock) =	\$238,121.85
SALE VOLUME MBF =	5,518
TOTAL \$/MBF =	\$47.61
TOTAL \$/MBF (Minus Optional Rock) =	\$43.15

Profit and Risk costs are accounted on an individual basis.

Compiled by: David Stone

Date: January 24, 2024

SUMMARY OF ROAD

Sale: Ghost Town Sorts

Road: 2400

Required
Pre-Haul Maintenance- 19+46 stations
0.37 miles

Required Abandonment- stations
0.00 miles

Required Reconstruction 0.00 stations
0.00 miles

Optional Reconstruction stations
0.00 miles

Required Construction - 0.00 stations
0.00 miles

Optional Construction - stations
0.00 miles

PRE-HAUL MAINTENANCE

CLEARING

EXCAVATION

Excavate ditchline and scatter material/ clean ditch -

19.46 stations @ \$13.30 per station = \$258.82

MISC.

Grade and shape existing road surface -

19.46 stations @ \$27.10 per station = \$527.37

Roll shaped road surface w/ vibratory roller prior to rocking -

19.46 stations @ \$14.40 per station = \$280.22

Grass seed -

2.9 lbs @ \$9.00 per lb = \$26.10

ENDHAUL

TOTAL CLEARING, GRUBBING, EXCAVATION, FILL, and MISC. **\$1,092.51**

RECONSTRUCTION

TOTAL CLEARING, GRUBBING, EXCAVATION, FILL, and MISC. **\$0.00**

CONSTRUCTION

TOTAL CLEARING, GRUBBING, EXCAVATION, FILL, and MISC. **\$0.00**

CULVERTS - MATERIALS & INSTALLATION

Culverts & Bands

0	LF of 18"	\$0.00		0	LF of 24"	\$0.00
0	LF of 30"	\$0.00		0	LF of 36"	\$0.00 w/bevel
0	LF of 42"	\$0.00	w/gasket-bevel	0	LF of 48"	\$0.00
0	LF of 54"	\$0.00		0	LF of 60"	\$0.00
0	LF of 66"	\$0.00		0	LF of 72"	\$0.00
		\$0.00				\$0.00

Half Rounds

0	LF of 24"	\$0.00		0	LF of 30"	\$0.00
0	LF of 36"	\$0.00		0	LF of 42"	\$0.00
		\$0.00				\$0.00

Culvert Stakes & Markers

0	stakes	\$0.00				
0	markers	\$0.00				
		\$0.00				\$0.00

TOTAL CULVERTS **\$0.00**

ROCK

0+00 to 19+46 Spot Rock

60 cy. of 1 1/4" Minus @ \$24.66 per c.y. = \$1,479.60

TOTAL ROCK **\$1,479.60**

ADDITIONAL REQUIREMENTS

TOTAL ADDITIONAL REQUIREMENTS **\$0.00**

ABANDONMENT

TOTAL ABANDONMENT **\$0.00**

Required
Pre-Haul Maintenance- \$2,572.11

Required Reconstruction \$0.00

Required Abandonment- \$0.00

Optional Reconstruction \$0.00

Required Construction - \$0.00

Optional Construction - \$0.00

SUBTOTAL **\$2,572.11**

TOTAL \$2,572.11

COST PER STATION \$132.17

SUMMARY OF ROAD

Sale: Ghost Town Sorts

Road: 2411

Required
Pre-Haul Maintenance- 24+88 stations
0.47 miles

Required
Reconstruction - 0.00 stations
0.00 miles

Required
Construction - 0.00 stations
0.00 miles

Required Abandonment- 0.00 stations
0.00 miles

Optional
Reconstruction - 0.00 stations
0.00 miles

Optional
Construction - 0.00 stations
0.00 miles

PRE-HAUL MAINTENANCE

CLEARING

EXCAVATION

Excavate ditchline and scatter material/ clean ditch -

24.88 stations @ \$13.30 per station \$330.90

MISC.

Grade and shape existing road surface -

24.88 stations @ \$27.10 per station \$674.25

Roll shaped road surface w/ vibratory roller prior to rocking -

24.88 stations @ \$14.40 per station \$358.27

Grass seed -

3.6 lbs @ \$9.00 per lb \$32.40

ENDHAUL

TOTAL CLEARING, GRUBBING, EXCAVATION, FILL, and MISC. **\$1,395.82**

RECONSTRUCTION

TOTAL CLEARING, GRUBBING, EXCAVATION, FILL, and MISC. **\$0.00**

CONSTRUCTION

TOTAL CLEARING, GRUBBING, EXCAVATION, FILL, and MISC. **\$0.00**

CULVERTS - MATERIALS & INSTALLATION

Culverts

0	LF of 18"	\$0.00	0	LF of 24"	\$0.00
0	LF of 30"	\$0.00	0	LF of 36"	\$0.00
0	LF of 42"	\$0.00	0	LF of 48"	\$0.00
0	LF of 54"	\$0.00	0	LF of 60"	\$0.00
0	LF of 66"	\$0.00	0	LF of 72"	\$0.00
		<u>\$0.00</u>			<u>\$0.00</u>

Half Rounds

0	LF of 24"	\$0.00	0	LF of 30"	\$0.00
0	LF of 36"	\$0.00	0	LF of 42"	\$0.00
		<u>\$0.00</u>			<u>\$0.00</u>

Culvert Stakes & Markers

0	stakes	\$0.00
0	markers	\$0.00
		<u>\$0.00</u>

TOTAL CULVERTS **\$0.00**

ROCK

0+00 to 24+88 Spot Rock 100 cy. of 1 1/4" Minus @ \$30.58 per c.y. = \$3,058.00

\$3,058.00

ADDITIONAL REQUIREMENTS

TOTAL ADDITIONAL REQUIREMENTS **\$0.00**

ABANDONMENT

TOTAL ABANDONMENT **\$0.00**

Required
Pre-Haul Maintenance- \$4,453.82

Required
Reconstruction - \$0.00

SUBTOTAL **\$4,453.82**

Required Abandonment- \$0.00

Optional
Reconstruction - \$0.00

Required Construction - \$0.00

Optional
Construction - \$0.00

TOTAL \$4,453.82

COST PER STATION \$179.01

SUMMARY OF ROAD

Sale:	Ghost Town Sorts		Road:	2418	
Required Pre-Haul Maintenance-	137+44 2.60	stations miles	Required Reconstruction -	0.00	stations miles
Required Abandonment-	0.00	stations miles	Optional Reconstruction -	0.00	stations miles
			Required Construction -	0.00	stations miles
			Optional Construction -	0.00	stations miles

PRE-HAUL MAINTENANCE

CLEARING

EXCAVATION

Excavate ditchline and scatter material/ clean ditch - 137.44 stations @ \$13.30 per station \$1,827.95

MISC.

Grade and shape existing road surface - 137.44 stations @ \$27.10 per station \$3,724.62
 Roll shaped road surface w/ vibratory roller prior to rocking - 137.44 stations @ \$14.40 per station \$1,979.14
 Construct landings - 2 @ \$185.50 each \$371.00
 Grass seed - 22.0 lbs @ \$9.00 per lb \$198.00

ENDHAUL

TOTAL CLEARING, GRUBBING, EXCAVATION, FILL, and MISC. **\$8,100.71**

RECONSTRUCTION

TOTAL CLEARING, GRUBBING, EXCAVATION, FILL, and MISC. **\$0.00**

CONSTRUCTION

TOTAL CLEARING, GRUBBING, EXCAVATION, FILL, and MISC. **\$0.00**

CULVERTS - MATERIALS & INSTALLATION

Culverts

0	LF of 18"	\$0.00		0	LF of 24"	\$0.00
0	LF of 30"	\$0.00		0	LF of 36"	\$0.00
0	LF of 42"	\$0.00		0	LF of 48"	\$0.00
0	LF of 54"	\$0.00		0	LF of 60"	\$0.00
0	LF of 66"	\$0.00		0	LF of 72"	\$0.00
		\$0.00				\$0.00

Half Rounds

0	LF of 24"	\$0.00		0	LF of 30"	\$0.00
0	LF of 36"	\$0.00		0	LF of 42"	\$0.00
		\$0.00				\$0.00

Culvert Stakes & Markers

0	stakes	\$0.00				
0	markers	\$0.00				
		\$0.00				\$0.00

TOTAL CULVERTS **\$0.00**

ROCK

0+00 to 137+44 Spot Rock Landings 300 cy. of 1 1/4" Minus @ \$28.63 per c.y.= \$8,589.00
 82 cy. of 3" Jaw Run @ \$26.25 per c.y.= \$2,152.50
TOTAL ROCK \$10,741.50

ADDITIONAL REQUIREMENTS

TOTAL ADDITIONAL REQUIREMENTS **\$0.00**

ABANDONMENT

TOTAL ABANDONMENT **\$0.00**

Required Pre-Haul Maintenance-	\$18,842.21	Required Reconstruction -	\$0.00			
Required Abandonment-	\$0.00	Optional Reconstruction -	\$0.00			
Required Construction -	\$0.00	Optional Construction -	\$0.00			
				SUBTOTAL		\$18,842.21
				TOTAL		\$18,842.21

COST PER STATION \$137.09

SUMMARY OF ROAD

Sale: Ghost Town Sorts

Road: 2418A-1

Required Pre-Haul Maintenance-	43+00 0.81	stations miles	Required Reconstruction -	0.00	stations miles
Required Abandonment-	0.00	stations miles	Optional Reconstruction -	0.00	stations miles
			Required Construction -	0.00	stations miles
			Optional Construction -	0.00	stations miles

PRE-HAUL MAINTENANCE

CLEARING

EXCAVATION

Construct sediment trap at station 11+50 -	1	@	\$75.00	each	\$75.00
Excavate ditchline and scatter material/ clean ditch -	43.00	stations @	\$19.95	per station	\$857.85

MISC.

Grade and shape existing road surface -	43.00	stations @	\$27.10	per station	\$1,165.30
Roll shaped road surface w/ vibratory roller prior to rocking -	43.00	stations @	\$14.40	per station	\$619.20
Construct landing -	4	@	\$185.50	each	\$742.00
Grass seed -	13.0	lbs @	\$9.00	per lb	\$117.00

ENDHAUL

TOTAL CLEARING, GRUBBING, EXCAVATION, FILL, and MISC. **\$3,576.35**

RECONSTRUCTION

TOTAL CLEARING, GRUBBING, EXCAVATION, FILL, and MISC. **\$0.00**

CONSTRUCTION

TOTAL CLEARING, GRUBBING, EXCAVATION, FILL, and MISC. **\$0.00**

CULVERTS - MATERIALS & INSTALLATION

<u>Culverts</u>					
96	LF of 18"	\$2,388.54		0	LF of 24" \$0.00
0	LF of 30"	\$0.00		0	LF of 36" \$0.00
0	LF of 42"	\$0.00		0	LF of 48" \$0.00
0	LF of 54"	\$0.00		0	LF of 60" \$0.00
0	LF of 66"	\$0.00		0	LF of 72" \$0.00
		\$2,388.54			\$0.00
<u>Half Rounds</u>					
0	LF of 24"	\$0.00		0	LF of 30" \$0.00
0	LF of 36"	\$0.00		0	LF of 42" \$0.00
		\$0.00			\$0.00
<u>Culvert Stakes & Markers</u>					
0	stakes	\$0.00			
3	markers	\$33.00			
		\$33.00			
				TOTAL CULVERTS	\$2,421.54

ROCK

Spot Rock 0+00 to 43+00	250	cy. of	1 1/4" Minus	@	\$29.80	per c.y.=	\$7,450.00
Energy Dissipator/Headwall - culverts	5.5	cy. of	Riprap LL	@	\$31.17	per c.y.=	\$171.44
Landings	164	cy. of	3" Jaw Run	@	\$28.34	per c.y.=	\$4,647.76
						TOTAL ROCK	\$12,269.20

ADDITIONAL REQUIREMENTS

TOTAL ADDITIONAL REQUIREMENTS **\$0.00**

ABANDONMENT

TOTAL ABANDONMENT **\$0.00**

Required Pre-Haul Maintenance-	\$18,267.09	Required Reconstruction -	\$0.00		
Required Abandonment-	\$0.00	Optional Reconstruction -	\$0.00		SUBTOTAL
Required Construction -	\$0.00	Optional Construction -	\$0.00		\$18,267.09
					TOTAL
					\$18,267.09

COST PER STATION \$424.82

SUMMARY OF ROAD

Sale: Ghost Town Sorts

Road: 2418A-2

Required Pre-Haul Maintenance - 24+45 stations miles 0.46	Required Reconstruction - 0.00 stations miles Optional Reconstruction - 0.00 stations miles	Required Construction - 0.00 stations miles Optional Construction - 0+00 stations miles 0.00
--	--	--

PRE-HAUL MAINTENANCE

CLEARING

EXCAVATION

Excavate ditchline and scatter material/ clean ditch - 24.45 stations @ \$19.95 per station \$487.78

MISC.

Grade and shape existing road surface - 24.45 stations @ \$27.10 per station \$662.60
 Roll shaped road surface w/ vibratory roller prior to rocking - 24.45 stations @ \$14.40 per station \$352.08
 Construct landing - 4 @ \$185.50 each \$742.00
 Grass seed - 8.9 lbs @ \$9.00 per lb \$80.10

ENDHAUL

TOTAL CLEARING, GRUBBING, EXCAVATION, FILL, and MISC. **\$2,324.56**

RECONSTRUCTION

TOTAL CLEARING, GRUBBING, EXCAVATION, FILL, and MISC. **\$0.00**

CONSTRUCTION

TOTAL CLEARING, GRUBBING, EXCAVATION, FILL, and MISC. **\$0.00**

CULVERTS - MATERIALS & INSTALLATION

Culverts

90	LF of 18"	\$2,243.04	0	LF of 24"	\$0.00
0	LF of 30"	\$0.00	0	LF of 36"	\$0.00
0	LF of 42"	\$0.00	0	LF of 48"	\$0.00
0	LF of 54"	\$0.00	0	LF of 60"	\$0.00
0	LF of 66"	\$0.00	0	LF of 72"	\$0.00
		\$2,243.04			\$0.00

Half Rounds

0	LF of 24"	\$0.00	0	LF of 30"	\$0.00
0	LF of 36"	\$0.00	0	LF of 42"	\$0.00
		\$0.00			\$0.00

Culvert Stakes & Markers

0	stakes	\$0.00
3	markers	\$33.00
		\$33.00

TOTAL CULVERTS **\$2,276.04**

ROCK

0+00 to 24+45 Spot Rock 230 cy. of 1 1/4" Minus @ \$30.12 per c.y.= \$6,927.60
 Energy Dissipator/Headwall - culverts 3.5 cy. of Riprap LL @ \$32.02 per c.y.= \$112.07
 Landings 164 cy. of 3" Jaw Run @ \$28.75 per c.y.= \$4,715.00
TOTAL ROCK **\$11,754.67**

ADDITIONAL REQUIREMENTS

Construct Earthen Barricade - 24+45 1 @ \$188.00 each \$188.00
TOTAL ADDITIONAL REQUIREMENTS **\$188.00**

DECOMMISSIONING

TOTAL ABANDONMENT **\$0.00**

Required Pre-Haul Maintenance - \$16,543.27	Required Reconstruction - \$0.00	
Required Decommissioning - \$0.00	Optional Reconstruction - \$0.00	SUBTOTAL \$16,543.27
Required Construction - \$0.00	Optional Construction - \$0.00	TOTAL \$16,543.27

COST PER STATION \$676.62

SUMMARY OF ROAD

Sale: Ghost Town Sorts Road: 2418A-3

Required Pre-Haul Maintenance- 11+62 0.22 stations miles	Required Reconstruction - 0.00 stations miles	Required Construction - 0.00 stations miles
Required Decommissioning- 0.00 stations miles	Optional Reconstruction - 0.00 stations miles	Optional Construction - 0.00 stations miles

PRE-HAUL MAINTENANCE

CLEARING

EXCAVATION

Excavate ditchline and scatter material/ clean ditch - 11.62 stations @ \$33.25 per station \$386.37

MISC.

Grade and shape existing road surface - 11.62 stations @ \$27.10 per station \$314.90
 Roll shaped road surface w/ vibratory roller prior to rocking - 11.62 stations @ \$14.40 per station \$167.33
 Construct landing - 3 @ \$185.50 each \$556.50
 Grass seed - 7.1 lbs @ \$9.00 per lb \$63.90

ENDHAUL

TOTAL CLEARING, GRUBBING, EXCAVATION, FILL, and MISC. **\$1,489.00**

RECONSTRUCTION

TOTAL CLEARING, GRUBBING, EXCAVATION, FILL, and MISC. **\$0.00**

CONSTRUCTION

TOTAL CLEARING, GRUBBING, EXCAVATION, FILL, and MISC. **\$0.00**

CULVERTS - MATERIALS & INSTALLATION

<u>Culverts</u>			
120	LF of 18"	\$2,990.72	0 LF of 24" \$0.00
0	LF of 30"	\$0.00	0 LF of 36" \$0.00
0	LF of 42"	\$0.00	0 LF of 48" \$0.00
0	LF of 54"	\$0.00	0 LF of 60" \$0.00
0	LF of 66"	\$0.00	0 LF of 72" \$0.00
		<u>\$2,990.72</u>	<u>\$0.00</u>
<u>Half Rounds</u>			
0	LF of 24"	\$0.00	0 LF of 30" \$0.00
0	LF of 36"	\$0.00	0 LF of 42" \$0.00
		<u>\$0.00</u>	<u>\$0.00</u>
<u>Culvert Stakes & Markers</u>			
0	stakes	\$0.00	
4	markers	\$44.00	
		<u>\$44.00</u>	
			<u>TOTAL CULVERTS</u> \$3,034.72

ROCK

Energy Dissipator/Headwall - culverts 4.0 cy. of Riprap LL @ \$29.99 per c.y.= \$119.96
 0+00 to 11+62 515 cy. of 3" Jaw Run @ \$31.31 per c.y.= \$16,124.65
TOTAL ROCK \$16,244.61

ADDITIONAL REQUIREMENTS

TOTAL ADDITIONAL REQUIREMENTS **\$0.00**

DECOMMISSIONING

TOTAL DECOMMISSIONING **\$0.00**

Required Pre-Haul Maintenance- \$20,768.33	Required Reconstruction - \$0.00	
Required Decommissioning- \$0.00	Optional Reconstruction - \$0.00	SUBTOTAL \$20,768.33
Required Construction - \$0.00	Optional Construction - \$0.00	
		TOTAL \$20,768.33
		COST PER STATION \$1,787.29

SUMMARY OF ROAD

Sale: Ghost Town Sorts

Road: 2418B

Required Pre-Haul Maintenance- 16+86 stations 0.32 miles	Required Reconstruction - 0.00 stations 0.00 miles	Required Construction - 0.00 stations 0.00 miles
Required Decommissioning- 0.00 stations 0.00 miles	Optional Reconstruction - 0.00 stations 0.00 miles	Optional Construction - 0.00 stations 0.00 miles

PRE-HAUL MAINTENANCE

CLEARING

EXCAVATION

Excavate ditchline and scatter material/ clean ditch - 16.86 stations @ \$19.95 per station \$336.36

MISC.

Grade and shape existing road surface - 16.86 stations @ \$27.10 per station \$456.91
 Roll shaped road surface w/ vibratory roller prior to rocking - 16.86 stations @ \$14.40 per station \$242.78
 Construct landing - 2 @ \$185.50 each \$371.00
 Grass seed - 5.4 lbs @ \$9.00 per lbs \$48.60

ENDHAUL

TOTAL CLEARING, GRUBBING, EXCAVATION, FILL, and MISC. **\$1,455.65**

RECONSTRUCTION

TOTAL CLEARING, GRUBBING, EXCAVATION, FILL, and MISC. **\$0.00**

CONSTRUCTION

TOTAL CLEARING, GRUBBING, EXCAVATION, FILL, and MISC. **\$0.00**

CULVERTS - MATERIALS & INSTALLATION

Culverts & Bands			
0	LF of 18"	\$0.00	
0	LF of 30"	\$0.00	
0	LF of 42"	\$0.00	w/gasket-bevel
0	LF of 54"	\$0.00	w/gasket-bevel
0	LF of 66"	\$0.00	
		\$0.00	
Half Rounds			
0	LF of 24"	\$0.00	
0	LF of 36"	\$0.00	
		\$0.00	
Culvert Stakes & Markers			
0	stakes	\$0.00	
0	markers	\$0.00	
		\$0.00	
			TOTAL CULVERTS

\$0.00

ROCK

0+00 to 16+86 Spot Rock 150 cy. of 1 1/4" Minus @ \$28.62 per c.y.= \$4,293.00
 Landing 82 cy. of 3" Jaw Run @ \$27.28 per c.y.= \$2,236.96
TOTAL ROCK

\$6,529.96

ADDITIONAL REQUIREMENTS

TOTAL ADDITIONAL REQUIREMENTS **\$0.00**

DECOMMISSIONING

TOTAL DECOMMISSIONING **\$0.00**

Required Pre-Haul Maintenance- \$7,985.61	Required Reconstruction - \$0.00	
Required Decommissioning- \$0.00	Optional Reconstruction - \$0.00	SUBTOTAL \$7,985.61
Required Construction - \$0.00	Optional Construction - \$0.00	TOTAL \$7,985.61

COST PER STATION \$473.64

SUMMARY OF ROAD

Sale: Ghost Town Sorts

Road: 2418A1-A

Required Pre-Haul Maintenance - stations miles

Required Reconstruction - stations miles

Required Construction - stations miles

Required Abandonment - stations miles

Optional Reconstruction - stations miles
 miles

Optional Construction - stations miles

PRE-HAUL MAINTENANCE

TOTAL CLEARING, GRUBBING, EXCAVATION, FILL, and MISC. **\$0.00**

RECONSTRUCTION

CLEARING/GRUBBING

Scattering Organic Debris 0.22 acres @ \$1,010.00 per acre \$222.20
Remove large stumps - 3 @ \$117.00 each \$351.00

EXCAVATION

Reconstruct and Widen Road Prism/with ditchline - includes embankment 10.70 stations @ \$119.43 per station \$1,277.90
Construct sediment trap at station 2+95 - 1 @ \$75.00 each \$75.00
Construct ditchout - 10+70 1 @ \$91.00 each \$91.00
Remove buried logs @ stations: 1+55, & 3+05 - 2.50 hours @ \$280.00 per hour \$700.00
Grade and shape subgrade - 10.70 stations @ \$22.55 per station \$241.29

FILL

MISC.

Roll subgrade w/ vibratory roller prior to rocking - 10.70 stations @ \$18.00 per station \$192.60
Construct turnouts - 1 @ \$91.00 each \$91.00
Construct landings - 2 @ \$185.50 each \$371.00
Grass seed - 16.6 lbs @ \$9.00 per lbs \$149.40

ENDHAUL

TOTAL CLEARING, GRUBBING, EXCAVATION, FILL, and MISC. **\$3,762.39**

CONSTRUCTION

TOTAL CLEARING, GRUBBING, EXCAVATION, FILL, and MISC. **\$0.00**

CULVERTS - MATERIALS & INSTALLATION

Culverts & Bands

74	LF of 18"	\$1,834.86		74	LF of 24"	\$2,136.30
0	LF of 30"	\$0.00		0	LF of 36"	\$0.00
0	LF of 42"	\$0.00		0	LF of 48"	\$0.00
0	LF of 54"	\$0.00		0	LF of 60"	\$0.00
0	LF of 66"	\$0.00		0	LF of 72"	\$0.00
		<u>\$1,834.86</u>				<u>\$2,136.30</u>

Half Rounds

0	LF of 24"	\$0.00		0	LF of 30"	\$0.00
0	LF of 36"	\$0.00		0	LF of 42"	\$0.00
		<u>\$0.00</u>				<u>\$0.00</u>

Culvert Stakes & Markers

0	stakes	\$0.00				
4	markers	\$44.00				
		<u>\$44.00</u>				

TOTAL CULVERTS **\$4,015.16**

ROCK

Energy Dissipator/Headwall - culverts 13.5 cy. of Riprap LL @ \$32.03 per c.y. = \$432.41
0+00 to 10+70 634 cy. of 3" Jaw Run @ \$29.72 per c.y. = \$18,842.48
TOTAL ROCK **\$19,274.89**

ADDITIONAL REQUIREMENTS

Straw Mulching near streams - 0.10 acres @ \$860.00 per acre \$86.00
TOTAL ADDITIONAL REQUIREMENTS **\$86.00**

ABANDONMENT

TOTAL ABANDONMENT **\$0.00**

Required Pre-Haul Maintenance -

Required Reconstruction -

SUBTOTAL **\$27,138.44**

Required Abandonment -

Optional Reconstruction -

Required Construction -

Optional Construction -

TOTAL **\$27,138.44**

COST PER STATION **\$2,536.30**

SUMMARY OF ROAD

Sale: Ghost Town Sorts

Road: 2418B-1

Required Haul Maintenance -	Pre-	<input style="width: 50px; height: 20px;" type="text"/> 0.00 stations miles	Required Reconstruction -	<input style="width: 50px; height: 20px;" type="text"/> 0.00 stations miles	Required Construction -	<input style="width: 50px; height: 20px;" type="text"/> 0.00 stations miles
Required Abandonment-		<input style="width: 50px; height: 20px;" type="text"/> 5+65 stations 0.11 miles	Optional Reconstruction -	<input style="width: 50px; height: 20px;" type="text"/> 9+55 stations 0.18 miles	Optional Construction -	<input style="width: 50px; height: 20px;" type="text"/> 0.00 stations miles

PRE-HAUL MAINTENANCE

TOTAL CLEARING, GRUBBING, EXCAVATION, FILL, and MISC. **\$0.00**

RECONSTRUCTION

CLEARING/GRUBBING

Scatter Organic Debris	0.20	acres @	\$1,010.00	per acre	\$202.00
Remove large stumps -	3	@	\$117.00	each	\$351.00

EXCAVATION

Reconstruct and Widen Road Prism/with ditchline - includes embankment	9.55	stations @	\$119.43	per station	\$1,140.56
Grade and shape subgrade -	9.55	stations @	\$22.55	per station	\$215.35

FILL

MISC.

Roll subgrade w/ vibratory roller prior to rocking -	9.55	stations @	\$18.00	per station	\$171.90
Construct turnouts -	1	@	\$91.00	each	\$91.00
Construct landing -	2	@	\$185.50	each	\$371.00
Grass seed -	15.0	lbs @	\$9.00	per lbs	\$135.00

ENDHAUL

TOTAL CLEARING, GRUBBING, EXCAVATION, FILL, and MISC. **\$2,677.81**

CONSTRUCTION

TOTAL CLEARING, GRUBBING, EXCAVATION, FILL, and MISC. **\$0.00**

CULVERTS - MATERIALS & INSTALLATION

Culverts

60	LF of 18"	\$1,495.36	0	LF of 24"	\$0.00
0	LF of 30"	\$0.00	0	LF of 36"	\$0.00
0	LF of 42"	\$0.00	0	LF of 48"	\$0.00
0	LF of 54"	\$0.00 w/gasket-bevel	0	LF of 60"	\$0.00 w/gasket-bevel
0	LF of 66"	\$0.00	0	LF of 72"	\$0.00
		\$1,495.36			\$0.00

Half Rounds

0	LF of 24"	\$0.00	0	LF of 30"	\$0.00
0	LF of 36"	\$0.00	0	LF of 42"	\$0.00
		\$0.00			\$0.00

Culvert Stakes & Markers

0	stakes	\$0.00
2	markers	\$22.00
		\$22.00

TOTAL CULVERTS **\$1,517.36**

ROCK

Energy Dissipator/Headwall - culverts	2.0	cy. of	Riprap LL	@	\$30.54 per c.y.= \$61.08
0+00 to 9+55	583	cy. of	3" Jaw Run	@	\$28.43 per c.y.= \$16,574.69
					TOTAL ROCK \$16,635.77

ADDITIONAL REQUIREMENTS

TOTAL ADDITIONAL REQUIREMENTS **\$0.00**

ABANDONMENT 9+55 to 15+20

Construct waterbar -	4	@	\$98.00	each	\$392.00
Construct Earthen Barricade - 9+55	1	@	\$188.00	each	\$188.00
Outslope roadway - excavate fill-slope, place material on cut-bank & contour -	5.65	stations @	\$83.33	per station	\$470.81
Grass seed - roadway and waste area	23.2	lbs @	\$9.00	per lbs	\$208.80
Mulching -	0.40	acres @	\$860.00	per acre	\$344.00
Construct waste area at 13+35 -	0.5	hours @	\$402.00	per hour	\$201.00
Excavation/end haul - Heavy abandonment/buried logs removals - 12+60 & 14+50	8.0	hours @	\$280.00	per hour	\$2,240.00
Live stream diversion at culvert removal sites -	4.0	hours @	\$30.00	per hour	\$120.00
Remove culverts - 12+60 & 14+50	4.0	hours @	\$178.00	per hour	\$712.00
Remove culvert from state lands -	2	@	\$100.00	each	\$200.00
Scatter woody debris -	1.0	hours @	\$178.00	per hour	\$178.00

TOTAL ABANDONMENT **\$5,254.61**

Required Pre-Haul Maintenance-	<input style="width: 50px; height: 20px;" type="text"/> \$0.00	Required Reconstruction -	<input style="width: 50px; height: 20px;" type="text"/> \$0.00		
Required Abandonment-	<input style="width: 50px; height: 20px;" type="text"/> \$5,254.61	Optional Reconstruction -	<input style="width: 50px; height: 20px;" type="text"/> \$20,830.94	SUBTOTAL	\$26,085.55
Required Construction -	<input style="width: 50px; height: 20px;" type="text"/> \$0.00	Optional Construction -	<input style="width: 50px; height: 20px;" type="text"/> \$0.00	TOTAL	\$26,085.55

COST PER STATION \$2,731.47

SUMMARY OF ROAD

Sale: Ghost Town Sorts

Road: 2422C-1

Required
Pre-Haul Maintenance- stations miles

Required Abandonment- stations miles

Required
Reconstruction - stations miles

Optional
Reconstruction - stations miles
 miles

Required
Construction - stations miles

Optional
Construction - stations miles
 miles

PRE-HAUL MAINTENANCE

TOTAL CLEARING, GRUBBING, EXCAVATION, FILL, and MISC. **\$0.00**

RECONSTRUCTION

TOTAL CLEARING, GRUBBING, EXCAVATION, FILL, and MISC. **\$0.00**

CONSTRUCTION

CLEARING/GRUBBING

Scattering Organic Debris	1.09	acres	@	\$1,010.00	per acre	\$1,100.90
Remove large stumps -	5		@	\$117.00	each	\$585.00

EXCAVATION

Road Construction Earthwork - includes embankment work	10.52	sta.	@	\$134.00	per sta. =	\$1,409.68
Grade and shape subgrade -	10.52		stations @	\$22.55	per station	\$237.23

FILL

MISC.

Roll subgrade w/ vibratory roller prior to rocking -	10.52	stations	@	\$18.00	per station	\$189.36
Construct turnout -	1		@	\$91.00	each	\$91.00
Construct landings -	3		@	\$185.50	each	\$556.50
Grass seed -	21.9		lbs @	\$9.00	per lbs	\$197.10

ENDHAUL

TOTAL CLEARING, GRUBBING, EXCAVATION, FILL, and MISC. **\$4,366.77**

CULVERTS - MATERIALS & INSTALLATION

Culverts

30	LF of 18"	\$747.68	0	LF of 24"	\$0.00
0	LF of 30"	\$0.00	0	LF of 36"	\$0.00
0	LF of 42"	\$0.00	0	LF of 48"	\$0.00
0	LF of 54"	\$0.00	0	LF of 60"	\$0.00
0	LF of 66"	\$0.00	0	LF of 72"	\$0.00
		\$747.68			\$0.00

Half Rounds

0	LF of 24"	\$0.00	0	LF of 30"	\$0.00
0	LF of 36"	\$0.00	0	LF of 42"	\$0.00
		\$0.00			\$0.00

Culvert Stakes & Markers

0	stakes	\$0.00			
1	markers	\$11.00			
		\$11.00			

TOTAL CULVERTS **\$758.68**

ROCK

Energy Dissipator/Headwall - culverts	1.0	cy. of	@	\$29.14	per c.y. =	\$29.14
0+00 to 10+52	906	cy. of	@	\$27.08	per c.y. =	\$24,534.48
						TOTAL ROCK

\$24,563.62

ADDITIONAL REQUIREMENTS

TOTAL ADDITIONAL REQUIREMENTS **\$0.00**

ABANDONMENT

TOTAL ABANDONMENT **\$0.00**

Required Pre-Haul Maintenance- <input type="text" value="\$0.00"/>	Required Reconstruction - <input type="text" value="\$0.00"/>	
Required Abandonment- <input type="text" value="\$0.00"/>	Optional Reconstruction - <input type="text" value="\$0.00"/>	
Required Construction - <input type="text" value="\$0.00"/>	Optional Construction - <input type="text" value="\$29,689.07"/>	

SUBTOTAL **\$29,689.07**

TOTAL **\$29,689.07**

COST PER STATION \$2,822.15

SUMMARY OF ROAD

Sale: Ghost Town Sorts

Road: 2410C-1

Required Pre-Haul Maintenance- stations miles
Required Abandonment- stations miles

Required Reconstruction - stations miles
Optional Reconstruction - stations miles

Required Construction - stations miles
Optional Construction - stations miles

PRE-HAUL MAINTENANCE

TOTAL CLEARING, GRUBBING, EXCAVATION, FILL, and MISC. **\$0.00**

RECONSTRUCTION

CLEARING/GRUBBING

Scattering Organic Debris 0.36 acres @ \$1,010.00 per acre \$363.60

EXCAVATION

Reconstruct and Widen Road Prism/with ditchline - includes embankment 10.55 stations @ \$92.63 per station \$977.25
Grade and shape subgrade - 10.55 stations @ \$22.55 per station \$237.90

FILL

MISC.

Roll subgrade w/ vibratory roller prior to rocking - 10.55 stations @ \$18.00 per station \$189.90
Grass seed and fertilize - 14.4 lbs @ \$9.00 per lbs \$129.60

ENDHAUL

TOTAL CLEARING, GRUBBING, EXCAVATION, FILL, and MISC. **\$1,898.25**

CONSTRUCTION

TOTAL CLEARING, GRUBBING, EXCAVATION, FILL, and MISC. **\$0.00**

CULVERTS - MATERIALS & INSTALLATION

Culverts

0 LF of 18" \$0.00 0 LF of 24" \$0.00
0 LF of 30" \$0.00 0 LF of 36" \$0.00
0 LF of 42" \$0.00 0 LF of 48" \$0.00
0 LF of 54" \$0.00 0 LF of 60" \$0.00
0 LF of 66" \$0.00 0 LF of 72" \$0.00
\$0.00 \$0.00

Half Rounds

0 LF of 24" \$0.00 0 LF of 30" \$0.00
0 LF of 36" \$0.00 0 LF of 42" \$0.00
\$0.00 \$0.00

Culvert Stakes & Markers

0 stakes \$0.00
0 markers \$0.00
\$0.00

TOTAL CULVERTS **\$0.00**

ROCK

0+00 to 10+55 354 cy. of 3" Jaw Run @ \$33.70 per c.y. = \$11,929.80
TOTAL ROCK **\$11,929.80**

ADDITIONAL REQUIREMENTS

TOTAL ADDITIONAL REQUIREMENTS **\$0.00**

ABANDONMENT

TOTAL ABANDONMENT **\$0.00**

Required Pre-Haul Maintenance- Required Reconstruction -

Required Abandonment- Optional Reconstruction -

Required Construction - Optional Construction -

SUBTOTAL **\$13,828.05**

TOTAL **\$13,828.05**

COST PER STATION **\$1,310.72**

SUMMARY OF ROAD

Sale: Ghost Town Sorts

Road: 2410C-1 EXT

Required Pre-Haul Maintenance- stations miles

Required Reconstruction - stations miles

Required Construction - stations miles

Required Abandonment- stations miles

Optional Reconstruction - stations miles

Optional Construction - stations miles
 miles

PRE-HAUL MAINTENANCE

TOTAL CLEARING, GRUBBING, EXCAVATION, FILL, and MISC. **\$0.00**

RECONSTRUCTION

TOTAL CLEARING, GRUBBING, EXCAVATION, FILL, and MISC. **\$0.00**

CONSTRUCTION

CLEARING/GRUBBING

Scattering Organic Debris 1.12 acres @ \$1,010.00 per acre \$1,131.20
Remove large stumps - 5 @ \$117.00 each \$585.00

EXCAVATION - includes drift endhaul

Road Construction Earthwork - includes embankment work 9.73 sta. @ \$134.00 per sta. = \$1,303.82
Grade and shape subgrade - 9.73 stations @ \$22.55 per station \$219.41

FILL

MISC.

Roll subgrade w/ vibratory roller prior to rocking - 9.73 stations @ \$18.00 per station \$175.14
Construct turnouts - 1 @ \$91.00 each \$91.00
Construct landings - 2 @ \$185.50 each \$371.00
Grass seed - 19.80 lbs @ \$9.00 per lbs \$178.20

ENDHAUL

TOTAL CLEARING, GRUBBING, EXCAVATION, FILL, and MISC. **\$4,054.77**

CULVERTS - MATERIALS & INSTALLATION

Culverts

150	LF of 18"	\$3,738.40	120	LF of 24"	\$3,421.50
0	LF of 30"	\$0.00	0	LF of 36"	\$0.00 w/bevel
0	LF of 42"	\$0.00	0	LF of 48"	\$0.00
0	LF of 54"	\$0.00 w/gasket-bevel	0	LF of 60"	\$0.00 w/gasket-bevel
0	LF of 66"	\$0.00	0	LF of 72"	\$0.00
		<u>\$3,738.40</u>			<u>\$3,421.50</u>

Half Rounds

0	LF of 24"	\$0.00	0	LF of 30"	\$0.00
0	LF of 36"	\$0.00	0	LF of 42"	\$0.00
		<u>\$0.00</u>			<u>\$0.00</u>

Culvert Stakes & Markers

0 stakes \$0.00
8 markers \$88.00
\$88.00

TOTAL CULVERTS **\$7,247.90**

ROCK

Energy Dissipator/Headwall - culverts 24.5 cy. of Riprap LL @ \$37.16 per c.y. = \$910.42
0+00 to 9+73 581 cy. of 3" Jaw Run @ \$34.07 per c.y. = \$19,794.67
TOTAL ROCK **\$20,705.09**

ADDITIONAL REQUIREMENTS

Straw Mulching near streams - 0.22 acres @ \$860.00 per acre \$189.20
TOTAL ADDITIONAL REQUIREMENTS **\$189.20**

ABANDONMENT

TOTAL ADDITIONAL REQUIREMENTS **\$0.00**

Required Pre-Haul Maintenance-

Required Reconstruction -

SUBTOTAL **\$32,196.96**

Required Abandonment-

Optional Reconstruction -

Required Construction -

Optional Construction -

TOTAL **\$32,196.96**

COST PER STATION \$3,309.04

ROCK DEVELOPMENT COST SUMMARY

Pit:	Signal Pit	Location:	SW¼ Sec. 03, T09N, R02E, W.M.
Sale:	Ghost Town Sorts	Road:	5209. CY
Swell:	1.30	Stockpile:	1000 c.y.
Shrinkage	0.00	Total Truck Loads:	6209. CY
Drill Pct.:	100%	In Place Total:	4776 c.y.

Access Road Construction	1.0 Stations	\$223.33 /Station	\$223.33
Pit Development & Cleanup including Clearing and Grubbing of Waste Area, Endhaul and place overburden, grass seeding.			
in Waste Area, spread and compact.	\$5.11 /cu.yd x	1047.0 cu.yds.	\$5,350.17
Drill & Shoot:	\$3.65 /cu.yd x	4776.0 cu.yds.	\$17,432.40
Rip Rock:	\$2.50 /cu.yd x	0 cu.yds.	\$0.00
Push Rock:	\$1.35 /cu.yd x	6209.0 cu.yds.	\$8,382.15
Load Crusher:	\$0.75 /cu.yd x	6155.0 cu.yds.	\$4,616.25
Crush 3" Jaw Run Rock:	\$4.05 /cu.yd x	4065 cu.yds.	\$16,463.25
Crush 1½" Minus Rock:	\$6.00 /cu.yd x	2090 cu.yds.	\$12,540.00
Load Crushed Rock in Truck:	\$0.75 /cu.yd x	6155.0 cu.yds.	\$4,616.25
Load Rip Rap Rock in Truck:	\$2.50 /cu.yd x	54.0 cu.yds.	\$135.00
	\$0.00 /ton x	0 tons =	\$0.00
	\$0.00 /ton x	0 tons =	\$0.00
	\$0.00 /ton x	0 tons =	\$0.00
	\$0.00 /cu.yd x	0 cu.yds.	\$0.00
		Subtotal	\$69,758.80

Move In/Set-up Mobile Jaw	1	@	\$950.95	=	\$950.95
Move In/Set-up Mobile 2 Stage Crusher	1	@	\$1,243.55	=	\$1,243.55
Move In/Set-up 3 Stage Crusher	0	@	\$0.00	=	\$0.00
Move In and set up Drill and Compressor	1	@	\$560.12	=	\$560.12
Move in Roller and Compactor	0	@	\$475.83	=	\$0.00
Move in Grader	0	@	\$350.26	=	\$0.00
Move in D-8	1	@	\$574.25	=	\$574.25
Move in Loader	1	@	\$541.66	=	\$541.66
Move in Excavator	2	@	\$502.41	=	\$1,004.82
Move in Trucks	5	@	\$179.29	=	\$896.45
Move in Water Truck	0	@	\$0.00	=	\$0.00
					Subtotal
					\$5,771.80

TOTAL PRODUCTION COSTS \$75,530.60

Base Cost = \$12.16 Per Cu.Yd.

Road Segment	Haul Cost /cu.yd.	Proc Cost /cu.yd.	Base Cst. /cu.yd.	Cost /cu.yd.	Number Cu. Yds	Speed (Mi/hr.)	One-Way Dist (ft)	ROCK COST
2400 0+00 to 19+46 Spot Rock 1 1/4" Minus	\$10.80	\$1.70	\$12.16	\$24.66	60	17	23401	\$1,479.60
2411 0+00 to 24+88 Spot Rock 1 1/4" Minus	\$16.72	\$1.70	\$12.16	\$30.58	100	17	39497	\$3,058.00
2418 0+00 to 137+44 Spot Rock 1 1/4" Minus	\$14.77	\$1.70	\$12.16	\$28.63	300	17	34195	\$8,589.00
2418 Landings 3" Jaw Run	\$13.19	\$0.90	\$12.16	\$26.25	82	17	31389	\$2,152.50
2418A-1 Spot Rock 0+00 to 43+00 1 1/4" Minus	\$15.94	\$1.70	\$12.16	\$29.80	250	17	37372	\$7,450.00
2418A-1 LL Energy Dissipator/Headwall - culverts	\$17.21	\$1.80	\$12.16	\$31.17	5.5	15	35372	\$171.44
2418A-1 Landings 3" Jaw Run	\$15.28	\$0.90	\$12.16	\$28.34	164	17	37072	\$4,647.76
2418A-2 0+00 to 24+45 Spot Rock 1 1/4" Minus	\$16.26	\$1.70	\$12.16	\$30.12	230	17	38246	\$6,927.60
2418A-2 LL Energy Dissipator/Headwall - culverts	\$18.06	\$1.80	\$12.16	\$32.02	3.5	15	37412	\$112.07
2418A-2 Landings 3" Jaw Run	\$15.69	\$0.90	\$12.16	\$28.75	164	17	38200	\$4,715.00
2418A-3 LL Energy Dissipator/Headwall - culverts	\$16.03	\$1.80	\$12.16	\$29.99	4.0	17	36882	\$119.96
2418A-3 0+00 to 11+62 3" Jaw Run	\$17.70	\$1.45	\$12.16	\$31.31	515	15	37204	\$16,124.65
2418B 0+00 to 16+86 Spot Rock 1 1/4" Minus	\$14.76	\$1.70	\$12.16	\$28.62	150	17	34154	\$4,293.00
2418B Landing 3" Jaw Run	\$14.22	\$0.90	\$12.16	\$27.28	82	17	34189	\$2,236.96
2418A-1A LL Energy Dissipator/Headwall - culverts	\$18.07	\$1.80	\$12.16	\$32.03	13.5	15	37427	\$432.41
2418A-1A 0+00 to 10+70 3" Jaw Run	\$16.11	\$1.45	\$12.16	\$29.72	634	17	37830	\$18,842.48
2418B-1 LL Energy Dissipator/Headwall - culverts	\$16.58	\$1.80	\$12.16	\$30.54	2.0	15	33849	\$61.08
2418B-1 0+00 to 9+55 3" Jaw Run	\$14.82	\$1.45	\$12.16	\$28.43	583	17	34315	\$16,574.69
2422C-1 LL Energy Dissipator/Headwall - culverts	\$15.18	\$1.80	\$12.16	\$29.14	1.0	15	30500	\$29.14
2422C-1 0+00 to 10+52 3" Jaw Run	\$13.47	\$1.45	\$12.16	\$27.08	906	17	30648	\$24,534.48
2410C-1 0+00 to 10+55 3" Jaw Run	\$20.09	\$1.45	\$12.16	\$33.70	354	17	48664	\$11,929.80
2410C-1 EXT LL Energy Dissipator/Headwall - culvert	\$23.20	\$1.80	\$12.16	\$37.16	24.5	15	49728	\$910.42
2410C-1 EXT 0+00 to 9+73 3" Jaw Run	\$20.46	\$1.45	\$12.16	\$34.07	581	17	49658	\$19,794.67
Stock Pile - 4253F @ 2+30 - 1 1/4" Minus	\$2.09	\$0.40	\$12.16	\$14.65	1000	5	350	\$14,650.00
				Total C.Y.	6209.0		Sub Total	\$169,836.71

TOTAL ROCKING COSTS \$169,836.71

Road Building Move-In Calculations

Sale: Ghost Town Sorts

LOWBOY HAUL (Round Trip)		
DIST. (mi)	ROADWAY	AVE SPEED (mph)
26.0	Highway	45
1.3	County/ Mainline	17
0.3	Steep Grades	10

No.	EQUIPMENT DESCRIPTION	Move in Cost	Pilot Cars	within Area			Within		Total Cost
				Move (\$/mile)	Begin Mileage	End Mileage	Total Miles	Area Cost	
0	Brush Cutter	\$264.09		\$17.80	0.00	0.00	0	\$0.00	\$0.00
1	Graders	\$413.30		\$19.83	0.00	0.00	7	\$138.81	\$552.11
0	Loader (Small)	\$264.09		\$15.00	0.00	0.00	0	\$0.00	\$0.00
0	Loader (Med. & Large)	\$413.30		\$17.00	0.00	0.00	0	\$0.00	\$0.00
1	Rollers & Compactors	\$264.09		\$27.14	0.00	0.00	7	\$189.98	\$454.07
0	Drill & Compressor	\$264.09		\$35.60	0.00	0.00	0	\$0.00	\$0.00
1	Excavators (Small)	\$264.09		\$50.00	0.00	0.00	6	\$300.00	\$564.09
1	Excavators (Large)	\$519.89	2	\$56.00	0.00	0.00	5	\$280.00	\$858.77
0	Tired Backhoes/Skidders	\$413.30		\$12.50	0.00	0.00	0	\$0.00	\$0.00
0	Tractors (D6)	\$413.30		\$32.43	0.00	0.00	0	\$0.00	\$0.00
0	Tractors (D7)	\$413.30		\$30.00	0.00	0.00	0	\$0.00	\$0.00
1	Tractor (D8)	\$519.89	2	\$57.43	0.00	0.00	5	\$287.15	\$865.92
5	Dump Truck (10 cy +)	\$112.90		\$11.00	0.00	0.00	7	\$385.00	\$2,489.50
0	Dump Truck (Off Hiway)	\$359.97		\$9.00	0.00	0.00	0	\$0.00	\$0.00
0	Water Truck (1500 Gal)	\$86.22		\$10.50	0.00	0.00	0	\$0.00	\$0.00
0	Water Truck (2500 Gal)	\$100.58		\$12.25	0.00	0.00	0	\$0.00	\$0.00

	TOTAL MOVE-IN COSTS: \$5,784.46
--	--



WASHINGTON STATE DEPARTMENT OF NATURAL RESOURCES

FOREST EXCISE TAX ROAD SUMMARY SHEET

Region: Pacific Cascade

Timber Sale Name: GHOST TOWN SORTS

Application Number: 30- 104392

EXCISE TAX APPLICABLE ACTIVITIES

Construction: 2,025 linear feet
Road to be constructed (optional and required) but not abandoned

Reconstruction: 3,080 linear feet
Road to be reconstructed (optional and required) but not abandoned

Abandonment: 565 linear feet
Abandonment of existing roads not reconstructed under the contract

Decommission: 0 linear feet
Road to be made undriveable but not officially abandoned.

Pre-Haul Maintenance: 27,771 linear feet
Existing road to receive maintenance work (optional and required) prior to haul

EXCISE TAX EXEMPT ACTIVITIES

Temporary Construction: 0 linear feet
Roads to be constructed (optional and required) and then abandoned

Temporary Reconstruction: 0 linear feet
Roads to be reconstructed (optional and required) and then abandoned

All parties must make their own assessment of the taxable or non-taxable status of any work performed under the timber sale contact. The Department of Revenue bears responsibility for determining forest road excise taxes. The Department of Natural Resources developed this form to help estimate the impact of forest excise taxes. However, the information provided may not precisely calculate the actual amount of taxes due. The Department of Revenue is available for consultation by calling 1.800.548.8829.

(Revised 9/18)